

AMERICAN NATIONAL STANDARD

ANSI/ISA-5.1-2009

**Instrumentation Symbols
and Identification**

Approved 18 September 2009

ANSI/ISA-5.1-2009, Instrumentation Symbols and Identification

ISBN: 978-1-936007-29-5

Copyright © 2009 by ISA. All rights reserved. Not for resale. Printed in the United States of America. No part of this publication may be reproduced, stored in a retrieval system, or transmitted in any form or by any means (electronic, mechanical, photocopying, recording, or otherwise), without the prior written permission of the Publisher.

ISA
67 Alexander Drive
P. O. Box 12277
Research Triangle Park, North Carolina, 27709 USA

Preface (informative)

This preface is included for information purposes and is not part of ANSI/ISA-5.1-2009.

This standard has been prepared as part of the service of ISA, The International Society of Automation, toward the goal of uniformity in the field of industrial automation. To be of continuing value, this standard should not be static but should be subject to periodic review. ISA welcomes all comments and suggestions and asks that they be addressed to the Secretary, Standards and Practices Board; ISA; 67 Alexander Drive; P. O. Box 12277; Research Triangle Park, NC 27709; Telephone: (919) 549-8411; Fax: (919) 549-8288, e-mail: standards@isa.org.

The ISA Standards and Practices Department is aware of the growing need for attention to the metric system of units in general, and the International System of Units (SI) in particular, in the preparation of instrumentation standards. The Department will endeavor to introduce SI-acceptable metric units in all new and revised standards, recommended practices, and technical reports to the greatest extent possible. Standard for Use of the International System of Units (SI): The Modern Metric System, published by the American Society for Testing & Materials as IEEE/ASTM SI 10-97, and future revisions, will be the reference guide for definitions, symbols, abbreviations, and conversion factors.

It is the policy of ISA to encourage and welcome the participation of all concerned individuals and interests in the development of ISA standards, recommended practices, and technical reports. Participation in the ISA standards-making process by an individual in no way constitutes endorsement by the employer of that individual, of ISA, or of any of the standards, recommended practices, and technical reports that ISA develops.

CAUTION — ISA ADHERES TO THE POLICY OF THE AMERICAN NATIONAL STANDARDS INSTITUTE WITH REGARD TO PATENTS. IF ISA IS INFORMED OF AN EXISTING PATENT THAT IS REQUIRED FOR USE OF THIS STANDARD, IT WILL REQUIRE THE OWNER OF THE PATENT TO GRANT EITHER A ROYALTY-FREE LICENSE FOR USE OF THE PATENT BY USERS COMPLYING WITH THIS STANDARD OR A LICENSE ON REASONABLE TERMS AND CONDITIONS THAT ARE FREE FROM UNFAIR DISCRIMINATION.

EVEN IF ISA IS UNAWARE OF ANY PATENT COVERING THIS STANDARD, THE USER IS CAUTIONED THAT IMPLEMENTATION OF THIS STANDARD MAY REQUIRE USE OF TECHNIQUES, PROCESSES, OR MATERIALS COVERED BY PATENT RIGHTS. ISA TAKES NO POSITION ON THE EXISTENCE OR VALIDITY OF ANY PATENT RIGHTS THAT MAY BE INVOLVED IN IMPLEMENTING THIS STANDARD. ISA IS NOT RESPONSIBLE FOR IDENTIFYING ALL PATENTS THAT MAY REQUIRE A LICENSE BEFORE IMPLEMENTATION OF THIS STANDARD OR FOR INVESTIGATING THE VALIDITY OR SCOPE OF ANY PATENTS BROUGHT TO ITS ATTENTION. THE USER SHOULD CAREFULLY INVESTIGATE RELEVANT PATENTS BEFORE USING THIS STANDARD FOR THE USER'S INTENDED APPLICATION.

HOWEVER, ISA ASKS THAT ANYONE REVIEWING THIS STANDARD WHO IS AWARE OF ANY PATENTS THAT MAY IMPACT IMPLEMENTATION OF THIS STANDARD NOTIFY THE ISA STANDARDS AND PRACTICES DEPARTMENT OF THE PATENT AND ITS OWNER.

ADDITIONALLY, THE USE OF THIS STANDARD MAY INVOLVE HAZARDOUS MATERIALS, OPERATIONS, OR EQUIPMENT. THIS STANDARD CANNOT ANTICIPATE ALL POSSIBLE APPLICATIONS OR ADDRESS ALL POSSIBLE SAFETY ISSUES ASSOCIATED WITH USE IN HAZARDOUS CONDITIONS. THE USER OF THIS STANDARD MUST EXERCISE SOUND PROFESSIONAL JUDGMENT CONCERNING ITS USE AND APPLICABILITY UNDER THE USER'S PARTICULAR CIRCUMSTANCES. THE USER MUST ALSO CONSIDER THE APPLICABILITY OF ANY GOVERNMENTAL REGULATORY LIMITATIONS AND ESTABLISHED SAFETY AND HEALTH PRACTICES BEFORE IMPLEMENTING THIS STANDARD.

THE USER OF THIS STANDARD SHOULD BE AWARE THAT THIS STANDARD MIGHT BE AFFECTED BY ELECTRONIC SECURITY ISSUES. THE COMMITTEE HAS NOT ADDRESSED THE POTENTIAL ISSUES IN THIS VERSION.

Users may find the following book of value in applying ANSI/ISA-5.1-2009:

Control System Documentation: Applying Symbols and Identification, Thomas McAviney
www.isa.org/books.

Users of this standard are asked to send comments or suggestions to standards@isa.org.

The following served as voting members of the ISA5 Committee during development of ANSI/ISA-5.1-2009.

Name	Affiliation
Alvin Iverson, <i>Chair</i>	Ivy Optiks
Ian Verhappen, <i>Managing Director</i>	Industrial Automation Networks Inc
Thomas McAviney, <i>Past Managing Director</i>	Jacobs Engineering
James Carew, <i>Chair, ISA5.1</i>	Consultant
Gerald Barta	Mustang Engineering LP
Donald Frey	Reliatech Inc
Alex Habib	Consultant
Ganesier Ramachandran	Shell Global Solutions US

On behalf of the ISA5 Committee and the ISA Standards & Practices Board, we wish to recognize and thank James Carew for his outstanding work, technical expertise, and commitment in leading the revision of this widely used ISA standard, and Thomas McAviney for his valuable technical and editorial contributions.

Al Iverson, ISA5 Chair
 Ian Verhappen, ISA5 Managing Director

The ISA Standards and Practices Board approved this standard on 23 July 2009

Name	Affiliation
J. Tatera	Tatera & Associates Inc.
P. Brett	Honeywell Inc.
M. Coppler	Ametek Inc.
E. Cosman	The Dow Chemical Company
B. Dumortier	Schneider Electric
D. Dunn	Aramco Services Co.
R. Dunn	DuPont Engineering
J. Gilsinn	NIST/MEL
E. Iccayan	ACES Inc.
J. Jamison	Husky Energy Inc.
D. Kaufman	Honeywell
K. P. Lindner	Endress + Hauser Process Solutions AG
V. Maggioli	Feltronics Corp.
T. McAviney	Jacobs Engineering
G. McFarland	Emerson Process Mgmt. Power & Water Sol.
R. Reimer	Rockwell Automation
N. Sands	DuPont

H. Sasajima
T. Schnaare
I. Verhappen
R. Webb
W. Weidman
J. Weiss
M. Widmeyer
M. Zielinski

Yamatake Corp.
Rosemount Inc.
MTL Instrument Group
ICS Secure LLC
Worley Parsons
Applied Control Solutions LLC
Consultant
Emerson Process Management

This page intentionally left blank.

Contents

1	Purpose	13
2	Scope	13
3	Definitions.....	17
4	Identification letters table.....	25
5	Graphic symbol tables.....	31
6	Graphic symbol dimension tables	76
Annex A	Identification system guidelines (informative annex).....	85
Annex B	Graphic symbol guidelines (informative annex)	111
Table 4.1	— Identification letters	30
Table 5.1.1	— Instrumentation device and function symbols	36
Table 5.1.2	— Instrumentation device or function symbols, miscellaneous	37
Table 5.2.1	— Measurement symbols: primary elements and transmitters	38
Table 5.2.2	— Measurement symbols: measurement notations (4).....	39
Table 5.2.3	— Measurement symbols: primary elements	40
Table 5.2.4	— Measurement symbols: secondary instruments.....	43
Table 5.2.5	— Measurement symbols: auxiliary and accessory devices	44
Table 5.3.1	— Line symbols: instrument to process and equipment connections.....	45
Table 5.3.2	— Line symbols: instrument-to-instrument connections.....	46
Table 5.4.1	— Final control element symbols.....	48
Table 5.4.2	— Final control element actuator symbols.....	50
Table 5.4.3	— Self-actuated final control element symbol	52
Table 5.4.4	— Control valve failure and de-energized position indications.....	55
Table 5.5	— Functional diagramming symbols.....	56
Table 5.6	— Signal processing function block symbols.....	57
Table 5.7	— Binary logic symbols.....	64
Table 5.8	— Electrical schematic symbols	72
Table 6.1	— Dimensions for Tables 5.1.1 and 5.1.2	78
Table 6.2	— Dimensions for Tables 5.2.1, 5.2.2, 5.2.3, 5.2.4, and 5.2.5	79
Table 6.3	— Dimensions for Tables 5.3.1 and 5.3.2	80
Table 6.4	— Dimensions for Tables 5.4.1, 5.4.2, 5.4.3, and 5.4.4	81
Table 6.5	— Dimensions for Table 5.5	82
Table 6.6	— Dimensions for Table 5.6	82
Table 6.7	— Dimensions for Table 5.7	83
Table 6.8	— Dimensions for Table 5.8	84
Table A.1	— Typical Loop and Instrument Identification/Tag Numbers	99

Table A.2.1 — Allowable letter/number combinations for loop numbering schemes and first letters A to O	100
Table A.2.2 — Allowable letter/number combinations for loop numbering schemes and first letters P to VZZ	101
Table A.2.3 — Allowable letter/number combinations for loop numbering schemes and first letters W to ZDZ	102
Table A.3.1.1 — Allowable succeeding letters for readout/passive functions and first letters A to O (1) (4b)	103
Table A.3.1.2 — Allowable succeeding letters for readout/passive functions and first letters P to VZZ (1) (4b)	104
Table A.3.1.3 — Allowable succeeding letters for readout/passive functions and first letters W to ZDZ (1) (4b)	105
Table A.3.2.1 — Allowable succeeding letters for output/active function letters and first letters A to O (1) (4b2)	106
Table A.3.2.2 — Allowable succeeding letters for output/active function letters and first letters P to VZZ (1) (4b2)	107
Table A.3.2.3 — Allowable succeeding letters for output/active function letters and first letters W to ZDZ (1) (4b2)	108
Table A.4 — Loop and Identification Tag Number suffixes (1) (2)	109

Introduction (informative)

(1) This introduction, as well as any footnotes, endnotes, and informative annexes, is included for information purposes and as background on the evolution of this standard and not as a normative part of ANSI/ISA-5.1-2009.

(2) The instrumentation symbolism and identification systems described in this standard accommodate advances in technology and reflect the collective industrial experience gained since the original ISA Recommended Practice RP-5.1, published in 1949, was revised, affirmed, and subsequently published as ANSI/ISA-5.1-1984, and then reaffirmed in 1992.

(3) This 2009 version attempts to strengthen this standard in its role as a communication tool in all industries that depend on measurement and control systems to operate and safeguard their manufacturing processes, machines, and other equipment. Communication presupposes and is facilitated by a common language. This 2009 version of the standard continues to build on the foundation for that common language.

(4) When integrated into a system, the designations and symbols presented here form a dedicated language that communicates concepts, facts, intent, instructions, and knowledge about measurement and control systems in all industries.

(5) The 1949 recommended practice and the 1984 standard were published as non-mandatory rather than as mandatory consensus documents. As such, they had many of the strengths and the weaknesses of such standards. Their primary strength was that they could be used in widespread, interdisciplinary ways. Their main weakness was that they were not specific enough, in some cases, to satisfy the special requirements of particular interest groups.

(6) This revision is published as a consensus standard and contains both mandatory and non-mandatory statements that have been reviewed and approved by a large group of practitioners in the field of instrumentation and control. This group was well versed in the use of identification and symbol systems as a means of communicating the intent of measurement and control systems to all that need such information. It is hoped that the consensus reached by this group regarding what is mandatory and what is not will enhance the strengths and lessen the weaknesses of the previous issues.

(7) Versions of this standard have been in use for more than fifty years, and most of the identification letter and symbol meanings or definitions that were contained in ISA-RP5.1-1949 and ISA-5.1-1984 (R 1992), have taken on a proprietary nature and have become accepted industry practice and assumed to be mandatory. The meanings and definitions of new symbols will be mandatory. This action is being taken in response to questions and comments that occur frequently because of unclear definitions.

(8) Mandatory definitions or meanings for letters used in identification and for symbols used in graphic depiction of measurement and control devices and functions are given. Mandatory minimum symbol dimensions are given. Informative identification and graphic symbol guidelines include alternate identification and symbol definitions and usage methods. Consistency is the one criterion that should govern the selection and application of identification and graphic schemes.

(9) This standard has been viewed in the past as being oriented to the oil and chemical process industries. This perception, while not intended, resulted from the fact that people who wrote the original and previous revisions were mainly working in those industries. It is the intent of the ISA5 committee that ISA Technical Reports will be used to address this type of problem. It is hoped that the technical report format will be specific enough to satisfy the special requirements of particular interest groups by providing examples and guidelines for use of the identification and symbolization methods for specific industries. These industries include, but are not limited to, metal refining, power generation, pulp and paper, and discrete parts manufacturing. The technical report format presents the best approach for making this standard applicable to industries that may have many usages and accepted practices that are not used in

the process industries.

(10) The extensive examples in previous versions of this standard that illustrated identification and symbolization definitions and methods have been removed and will be moved to technical reports that will be prepared after publication of this revised standard.

(11) The symbols and identification methods contained in this standard have evolved by the consensus method and are intended for wide application throughout all industries. The symbols and designations are used as conceptualizing aids, as design tools, as teaching devices, and as a concise and specific means of communication in **all types and kinds** of technical, engineering, procurement, construction, and maintenance documents, and not just piping and instrumentation diagrams (P&IDs).

(12) Previous versions of this standard have been flexible enough to serve all of the uses just described, and it must continue to do so into the future. To this end, this revision clarifies the definitions of symbols, identification, and definitions for concepts that were previously described, such as, for example, shared display/control, distributed control, and programmable control. It also adds definitions for new symbols required for functional diagramming of instruments and simple electrical circuit diagrams.

(13) This revision extensively changes the format of ANSI/ISA-5.1-1984 (R 1992). Clauses 1, 2, and 3 are essentially the same as previously written with some additions and modifications. Clauses 4, 5 and 6 and informative Annexes A and B are new or extensively revised.

(14) Clause 4, "Identification letter tables," was previously Clause 5, "Tables." It is almost the same as the previous version and deals only with Table 4.1, "Identification letters," which was previously Table 1, "Identification letters."

(15) Clause 5, "Graphic symbol tables," is a new clause that contains new symbols and the symbols that were previously in Clause 6, "Drawings," presented in a table format that includes text describing the application of the symbols but no examples of their use.

(16) Clause 6, "Graphic symbol dimension tables," is a new clause that establishes minimum mandatory dimensions for the symbols shown in the tables in Clause 5 when used in the preparation of full-size engineering drawings.

(17) Annex A, "Identification system guidelines (Informative)," was previously Clause 4, "Outline of the Identification System," and presents the most commonly used instrumentation and function identification methods. Included are expanded "Allowable loop and function letter combination" tables and added "Allowable loop letter scheme" tables.

(18) Annex B, "Graphic symbol guidelines" (Informative), is a new informative clause that replaces the examples formerly given in Clause 6, "Drawings," to provide some limited assistance in the application of the symbols in Clause 5.

(19) Definitions for identification letters and symbols are now mandatory to reduce the confusion caused by giving meanings to identification and symbols not intended by this standard. At the same time, the number of symbology and tagging bubbles required to depict a measurement or control scheme was allowed to range from "everything must be shown" to the "minimum required to convey the instrumentation and functionality required." Guidelines are intended to aid in the application of identification and symbology and to include some of the known methods as alternate usages.

(20) The meanings of 'shared display, shared control,' and 'programmable logic control' have been clarified and expanded because of changes in technology and usage since their inception in ISA-5.3-1983, "Graphic Symbols for Distributed Control/Shared Display Instrumentation, Logic and Computer Systems." The commonly assumed meanings of 'circle-in-square' as distributed control system (DCS) functions and of 'diamond-in-square' as programmable logic controller (PLC) functions are no longer

accurate because they no longer reflect the currently acceptable meanings. DCSs and PLCs can both perform continuous and binary control functions. The same functions are performed by personal computers (PC) and by fieldbus and devicebus devices. Both 'circle-in-square' and 'diamond-in-square' symbols are classified as 'shared display, shared control.' 'Circle-in-square' will depict either (a) primary control system choice or (b) basic process control system (BPCS). 'Diamond-in-square' will depict either (a) alternate control system choice or (b) safety instrumented system (SIS). Users who continue to use the symbols as in the past should change to the revised meanings as soon as possible.

(21) This revision uses, with permission, information from the excellent SAMA (Scientific Apparatus Makers Association) PMC 22.1-1981, "Functional Diagramming of Instrument and Control Systems," a document still used by many control system engineers and designers. SAMA symbols and descriptions for functional diagramming of Instruments and control loops and for signal processing symbols and function blocks were adapted in ANSI/ISA-5.1-1984 (R 1992) for use in loop schematic diagrams. This revision adds the SAMA symbols and descriptions for logic function enclosures for use in functional diagrams, logic diagrams, and application software functions. Guidelines for a limited number of applications of the symbols will be found in Annex B, "Graphic symbol system guidelines (Informative)."

(22) The binary line symbols, which were introduced in ANSI/ISA-5.1-1984 (R 1992) to aid the batch processing industries, have been removed because of their general lack of use and acceptance and the many objections to their use. If their use is desired within the batch processing industries, an ISA Technical Report could be produced to cover this unique need.

(23) The many examples contained in Clause 6 of ANSI/ISA-5.1-1984 (R 1992) have been reduced in number and are now located in Annex B. It is hoped that ISA Technical Reports will be prepared based on this standard to cover the application of identification and symbolization methods and practices in the detail required by users in those many industries beyond the process industries, who depend on this standard in their daily work.

(24) The ISA5 committee and ISA5.1 subcommittee recognize and deeply appreciate the work of previous ISA5.1 subcommittees, and have tried to treat their work with the great respect it deserves.

(25) ISA5 and ISA5.1 also acknowledge the work done by the past ISA5.2 and ISA5.3 subcommittees in developing ISA-5.2-1976 (R1992), "Binary Logic Diagrams for Process Operations," and ISA-5.3-1983, "Graphic Symbols for Distributed Control/Shared Display Instrumentation, Logic and Computer Systems." The key elements of ISA-5.3-1983 were incorporated in ANSI/ISA-5.1-1984 (R 1992) and have been expanded in this revision. The key elements of ISA-5.2-1976 are incorporated and integrated with the logic symbols from SAMA PMC 22.1-1981 for symbolizing and describing binary functions. Guidelines for the application of the binary system can be found in Annex B (Informative), Graphic symbol system guidelines.

This page intentionally left blank.

1 Purpose

This standard establishes a uniform means of depicting and identifying instruments or devices and their inherent functions, instrumentation systems and functions, and application software functions used for measurement, monitoring, and control, by presenting a designation system that includes identification schemes and graphic symbols.

2 Scope

2.1 General

2.1.1 This standard is intended to meet the different procedures of various users who need to identify and graphically depict measurement and control equipment and systems. These differences are recognized when they are consistent with the objectives of this standard, by providing alternative symbol and identification methods.

2.1.2 A limited number of examples are provided that illustrate how to:

- a) Design an identification system and construct an identification number.
- b) Use graphic symbols to construct:
 - 1) Instrumentation schematic diagrams of the instruments, devices, and functions required for monitoring and control loops.
 - 2) Functional diagrams of instruments, loops, and application software functions.
 - 3) Binary logic diagrams.
 - 4) Ladder diagrams of electrical circuits.
- c) Add information and simplify diagrams.

2.1.3 Examples of identification and symbol applications are intended to illustrate basic concepts in the construction of the identification systems and diagrams covered by this standard that are applicable to all user industries.

2.2 Application to industries

2.2.1 This standard is suitable for use in the chemical, petroleum, power generation, metal refining, pulp and paper, and numerous other continuous, batch, discrete-part processing, and material-handling industries. These industries and others require the use of control system schematics, functional diagrams, and electrical schematics to describe the relationship to processing equipment and the functionality of measurement and control equipment.

2.3 Application to work activities

2.3.1 This standard is suitable for use whenever reference to measurement and control instrumentation, control devices and functions, and software applications and functions is required for identification and symbolization, such as:

- a) Design sketches.
- b) Teaching examples.
- c) Technical papers, literature, and discussions.
- d) Instrumentation, loop, logic, and functional diagrams.
- e) Function descriptions.
- f) Conceptual drawings including but not limited to:
 - 1) Process Flow Diagrams (PFD)
 - 2) Utility Flow Diagrams (UFD).
- g) Construction drawings including but not limited to:
 - 1) Engineering Flow Diagrams (EFD).
 - 2) Mechanical Flow Diagrams (MFD).
 - 3) Piping and Instrumentation Diagrams (P&ID).
 - 4) System Flow Diagrams (SFD).
- h) Specifications, purchase orders, manifests, and other lists.
- i) Identification and tag numbering of instruments and control functions.
- j) Installation, operating and maintenance instructions, drawings, and records.

2.3.2 This standard provides sufficient information to enable anyone who has a reasonable amount of process and instrumentation knowledge, and who is reviewing documents depicting measurement and control, to understand the means and purpose of the instrumentation shown.

2.3.3 The detailed knowledge of a specialist in instrumentation and/or control systems is not a prerequisite to understanding this standard.

2.4 Application to classes of instrumentation and to instrument functions

2.4.1 The identification and symbolism methods provided in this standard are applicable to all classes and types of measurement and control instruments and/or functions.

2.4.2 The methods can be used for, but are not limited to, describing and identifying:

- a) Discrete instruments and their functions.

- b) Shared display and control functions.
- c) Distributed control functions.
- d) Computer control functions.
- e) Programmable logic controller display and control functions.
- f) Application software display and control functions.

2.5 Classification of instrumentation

2.5.1 Instrumentation may be classified as primary, secondary, auxiliary, or accessory for assigning Loop and Functional Identities and symbols as defined in Clause 4 and shown in Annex A.

2.5.2 Primary instrumentation consists of measuring, monitoring, controlling, or calculating devices and hardware and their inherent functions and software functions that include, but are not limited to, transmitters, recorders, controllers, control valves, self-actuated safety and control devices, and application software functions that require or allow user-assigned identifications.

2.5.3 Secondary instrumentation consists of measuring, monitoring, or controlling devices and hardware that include, but are not limited to, level glasses, pressure gauges, thermometers, and pressure regulators.

2.5.4 Auxiliary instrumentation consists of devices and hardware that measure, control, or calculate and that are needed for effective operation of primary or secondary instrumentation; they include, but are not limited to, calculating devices, purge meters, sample handling systems, and instrument air sets.

2.5.5 Accessory instrumentation consists of devices and hardware that do not measure or control but are needed for effective operation of the measuring, monitoring, or control system; they include, but are not limited to, flowmeter tube run, straightening vanes, and seal pots.

2.6 Extent of loop and functional identification

2.6.1 This standard provides identification codes and methods for the alphanumeric identification of monitoring and controlling loops, instruments and functions.

2.6.2 These identification methods depend on tagging according to function and not according to construction or form. For example, a differential pressure transmitter is not identified as a differential pressure transmitter but as a:

- a) Flow transmitter when connected to an orifice plate when measuring flow.
- b) Level transmitter when connected to the side of a vessel when measuring liquid level.

2.6.3 The user is free to apply added identification by serial, equipment, unit, area, or plant number, or any other additional means required for the unique identification of a loop, instrument or function.

2.6.4 A unique function identification number shall be assigned to identify each:

- a) Loop instrument or device and its integral and/or inherent functions.

- b) *Loop-configurable* function, which requires or allows a unique user-assigned microprocessor or computer address.

2.7 Extent of symbolization

2.7.1 This standard provides symbol sets for the graphic depiction of a limited or total functionality of instruments and devices, entire monitor or control loops, or control circuits.

2.7.2 The amount of detail to be shown by the use of symbols depends on the purpose and audience for which the document is being prepared.

2.7.3 Sufficient symbols shall be used to show the functionality of the instrumentation and/or control loop being depicted; it is not considered necessary to provide a symbol for each instrument device and each function required by a loop.

2.7.4 Additional construction, fabrication, installation, and operation details of an instrument are better described in a suitable specification, data sheet, loop diagram, installation/wiring drawing, or sketch, or other document intended for those requiring such details.

2.8 Inclusion and modification of this standard in User engineering and design documents

2.8.1 This standard may be used and, if used, shall be credited by a User/Owner in the preparation of engineering, design, or project standards, guidelines, and specifications, either without exception or with exception per the following:

- a) Without exception, in which case this standard in its entirety shall be mandatory with respect to:

- 1) Letters assigned a specific meaning in Table 4.1.
- 2) Symbols and their assigned meanings in Tables 5.1 through 5.8.
- 3) Symbol dimensions in Tables 6.1 through 6.8.

- b) With exceptions, in which case the parts of this standard for which exception is:

- 1) Taken shall be fully described and detailed in the User/Owner standards, guidelines, or specifications and in drawing cover sheet legends and notes.
- 2) Not taken shall be mandatory.

2.8.2 Symbols different from those given in this standard and User's choice letters when used, shall be fully described and detailed in the User/Owner's standards, guidelines, or specifications and in drawing cover sheet legends and notes.

2.8.3 A User must choose a numbering scheme, graphic symbol, and other choices where required, and document those choices.

2.8.4 When a previous issue of this standard is included by reference with or without exception in User/Owner's engineering and design standards, guidelines or specifications, that standard in part or in its entirety shall be mandatory until such time as the User/Owner's guidelines or standards are revised.

2.8.5 Symbols and the meanings of letters and symbols from previous versions of this standard that are different from those contained in this version may continue to be used provided they are clearly referenced in the User's engineering and design standards, practices, and/or guidelines.

3 Definitions

3.1 Definitions

For the purposes of this standard, the following definitions apply. For additional information, see ISA-51.1-1979 (R 1993), "Process Instrumentation Terminology," and ANSI/ISA-75.05.01-2000 (R 2005), "Control Valve Terminology." Terms *italicized* in a definition are themselves defined elsewhere in this clause.

3.1.1 accessible:

a feature of a *device* or function, a feature of an interactive shared system function, or a feature that can be used or seen by an operator for the purpose of performing control operations, such as *setpoint* changes, auto-manual transfer, or on-off operations.

3.1.2 alarm:

an indicating device or function that provides a visible and/or audible indication if and when the value of a measured or initiating variable is outside of set limits, has changed from a safe to an unsafe condition, or has changed from a normal to an abnormal operating state or condition.

a) actuation may be by a *binary* or *analog device* or *function*.

b) indication may be by any or all of the following: annunciator *panels*, flashing lights, printers, buzzers, bells, horns, sirens, or shared graphic display systems.

3.1.3 analog:

a signal or *device* that has no *discrete* positions or states and changes value as its input changes value and when used in its simplest form, as in "*analog* signal" as opposed to "*binary* signal"; the term denotes a continuously varying quantity.

3.1.4 application *software*:

software specific to a user application that is *configurable* and in general contains logic sequences, permissive and limit expressions, control algorithms, and other code required to control the appropriate input, output, calculations, and decisions; see also *software*

3.1.5 assignable:

a system feature permitting channeling or directing of a signal from one *device* to another without the need for changes in wiring either by means of patching, switching, or via keyboard commands to the system.

3.1.6 auto-manual station:

a *manual loading station* or *control station* that also provides switching between manual and automatic control modes of a control *loop*; see also manual station.

3.1.7 balloon:

an alternate term for the circular symbol used to denote and identify the purpose of an *instrument* or *function* that may contain a tag number; see preferred term *bubble*.

3.1.8 basic process control system (BPCS):

instrumentation and systems that are installed to monitor and control normal production operations using, but not limited to combinations of single-loop pneumatic and electronic monitors and controllers, *programmable logic controllers* and *distributed control systems*.

(a) A BPCS is necessary to operate a plant or process.

3.1.9 behind the *panel*:

a location that in a broad sense means "not normally accessible to an operator," such as the rear of an instrument or control *panel*, an enclosed instrument rack or cabinet, or an instrument rack room within an area that contains a *panel*.

3.1.10 binary:

a signal or *device* that has only two *discrete* positions or states, and when used in its simplest form, as in "*binary signal*" as opposed to "*analog signal*," the term denotes an "on-off" or "high-low" state.

3.1.11 board:

a freestanding structure consisting of one or more sections, cubicles, or consoles that has groups of *discrete instruments* mounted on it, houses the operator-*process* interface, and is chosen to have a unique designation; see *panel*.

3.1.12 bubble:

the preferred term for the circle-based symbols used to denote and identify the purpose of an *instrument* or *function* that may contain a tag number; see alternate term *balloon*.

3.1.13 communication link:

a wire, cable, or electromagnetic network or bus system that connects dedicated microprocessor-based and computer-based systems so that they share a common database, and communicates according to a rigid protocol in a hierarchical and/or peer-to-peer relationship; see *datalink*.

a) wire or cable networks may be twisted pair, coaxial, telephone, or fiber optic.

b) electromagnetic networks may be radio or microwave.

3.1.14 computer control system:

a system in which all control action takes place within a control computer, such as a mainframe computer or mini-computer, which may be single or redundant.

3.1.15 computing *device*:

the preferred term for a *device* that performs one or more calculations or logic operations, or both, and transmits one or more resultant output signals; see also *computing relay*.

3.1.16 computing *relay*:

an alternate term for a *device* that performs one or more calculations or logic operations, or both, and transmits one or more resultant output signals; see also *computing device*.

3.1.17 computing function:

a *hardware* or *software* function that performs one or more calculations or logic operations, or both, and transmits one or more resultant output signals.

3.1.18 configurable:

a term for *devices* or systems whose functional and/or communication characteristics can be selected or rearranged through setting of *program switches*, *application software*, fill-in-the-blank forms, pull-down menus, entered values or text, and/or other methods, other than rewiring as a means of altering the configuration.

3.1.19 controller:

a *device* having an output that varies to regulate a controlled variable in a specified manner that may be a self-contained *analog* or *digital instrument*, or may be the equivalent of such an *instrument* in a shared-control system.

- a) an automatic *controller* varies its output automatically in response to a direct or indirect input of a measured *process variable*.
- b) a manual *controller*, or *manual loading station*, varies its output in response to a manual adjustment; it is not dependent on a measured *process variable*.
- c) a *controller* may be an integral element of other functional elements of a control *loop*.

3.1.20 control station:

a *manual loading station* that also provides *switching* between manual and automatic control modes of a control *loop*; see also *auto-manual station*.

- a). the operator interface of a *distributed control system* may be referred to as a *control station*.

3.1.21 control valve:

a *device*, other than a common, hand-actuated *process block valve* or self-actuated check valve, that directly manipulates the flow of one or more fluid *process streams*.

- a) the designation "hand *control valve*" shall be limited to hand-actuated valves that when used for *process throttling* require *identification* as an *instrument* or control *device*.

3.1.22 converter:

a *device* that receives information as one form of an *instrument* signal and transmits an output signal as another form, such as a current-to-pneumatic signal *converter*.

- a). an *instrument* that changes a *sensor's* output to a standard signal, is properly designated as a *transmitter*, not a *converter*; typically, a temperature element [TE] connects to a *transmitter* [TT], not to a *converter* [TY].

b) a *converter* is sometimes referred to as a *transducer*, a completely general term not recommended for signal conversion.

3.1.23 datalink:

a wire, cable, or electromagnetic network or bus system that connects field-located *devices* with dedicated microprocessors so that they share a common database and communicate according to a rigid protocol in a hierarchical and/or peer-to-peer relationship to other such *devices* and/or compatible microprocessor-based systems; see also *communication link*.

a) wire or cable networks may be twisted pair, coaxial, telephone, or fiber optic.

b) electromagnetic networks may be radio or microwave.

3.1.24 detector:

a *device* that is used to detect the presence of something, such as flammable or toxic gases or *discrete* parts; see also *primary element* and *sensor*.

3.1.25 device:

a piece of *instrument hardware* that is designed to perform a specific action or function, such as a *controller*, indicator, *transmitter*, annunciator, or *control valve*.

3.1.26 digital:

a signal or *device* that generates or uses *binary* digit signals to represent continuous values or *discrete* states.

3.1.27 discrete instrument

a *device* or *hardware* that has a separate entity, such as a single-case *controller* or recorder.

3.1.28 discrete signals:

signals that have any number of non-continuous distinct or defined states or positions.

a) *Binary* signals are a subset.

3.1.29 distributed control system (DCS):

instrumentation, input/output *devices*, control *devices* and operator interface *devices*, which in addition to executing stated control and indication functions, also permit transmission of control, *measurement*, and operating information to and from single or multiple-user specifiable locations, connected by single or multiple *communication links*.

3.1.30 field instrument:

an *instrument* that is not mounted on a *panel* or console or in a control room but commonly in the vicinity of its *primary element* or *final control element*, see local *instrument*.

3.1.31 final control element:

a *device*, such as a *control valve*, that directly controls the value of the manipulated variable of a control *loop*.

3.1.32 function:

the purpose of, or the action performed by, a *device* or *application software*.

3.1.33 hardware:

physical equipment directly involved in performing measuring, *monitoring*, and controlling *functions*.

3.1.34 high level control system (HLCS):

A system that provides sophistication above that of the BPCS; with *functions* typically based in process computer or higher level hardware that interacts with the process by manipulating setpoints in the BPCS.

(a) Control *functions* in the HLCS include, but are not limited to, statistical process control and model predictive control.

(b) An HLCS is not necessary to operate a plant or process.

3.1.35 identification:

the sequence of letters or numerals, or both, used to designate an individual *instrument*, *function*, or *loop*.

3.1.36 instrument:

a *device* used for direct or indirect *measurement*, *monitoring*, and/or control of a variable, including *primary elements*, indicators, *controllers*, *final control elements*, *computing devices*, and electrical *devices* such as annunciators, *switches*, and pushbuttons.

a) the term does not apply to a *devices* internal components or parts, such as receiver bellows or resistors.

3.1.37 instrumentation:

a collection of instruments, *devices*, *hardware*, or *functions* or their application for the purpose of measuring, *monitoring*, or controlling an industrial *process* or machine, or any combination of these.

3.1.38 local instrument:

an instrument that is not mounted on a *panel* or console or in a control room, but commonly in the vicinity of its *primary element* or *final control element*; see *field instrument*.

3.1.39 local panel:

a *panel* that is not a central or main *panel* and is commonly located in the vicinity of plant subsystems or sub-areas.

a) the term "*local panel instrument*" should not be confused with "*local instrument*".

3.1.40 loop:

instrumentation arranged as a combination of two or more instruments or *functions* arranged so that signals pass from one to another for the purpose of *measurement* and indication or control of a *process variable*.

a) a self-contained *device* that measures and controls a *process variable*.

3.1.41 manual loading station:

a *device* or *function* that has a manually adjustable output, and may also have indicators, lights, and/or other *functions*, that is used to actuate and/or modulate one or more *devices*, but does not provide *switching* between auto-manual modes of a control *loop*.

3.1.42 measurement:

the determination of the existence and/or magnitude of a *process variable*.

3.1.43 monitor:

a general term for an instrument or instrument system used to measure or sense the status or magnitude of one or more variables for the purpose of deriving useful information, and that sometimes means analyzer, indicator, or *alarm*.

3.1.44 monitor light:

a light that indicates which of a number of normal, but not abnormal, conditions of a system or *device* exists; see also *pilot light*.

3.1.45 panel:

a freestanding or built-in structure consisting of one or more sections, cubicles, consoles, or desks that has groups of instrument *hardware* mounted on it, houses the operator-*process* interface, and is given a unique designation.

3.1.46 panel-mounted:

an instrument or other *device* that is mounted on a *panel* or console and is *accessible* for an operator's normal use.

a) a *function* that is normally *accessible* to an operator in a shared-display system is the equivalent of a *discrete panel-mounted device*.

3.1.47 pilot light:

a light that indicates which of a number of normal conditions of a system or *device* exists; it is not an *alarm* light, which indicates an abnormal condition. See also *monitor light*.

3.1.48 primary element:

an external or internal instrument or system element that quantitatively converts the measured variable into a form suitable for *measurement*; see also *detector* and *sensor*.

a) an orifice plate is an external *primary element*

b) the *sensor* of a *transmitter* is an internal *primary element*.

3.1.49 process:

any operation or sequence of operations involving a change of energy, state, composition, dimension, or other properties that may be defined with respect to zero or some other defined initial value.

3.1.50 *process variable*:

any measurable property of a *process*; used in this standard to apply to all variables other than instrument signals between *devices* in a *loop*.

3.1.51 *program*:

a repeatable sequence of actions that defines the state of outputs as a fixed relationship to the state of inputs.

3.1.52 *programmable logic controller*:

a *controller*, usually with multiple inputs and outputs, that contains an alterable *program* that is typically used to control *binary* and/or *discrete* logic or sequencing *functions*, and may also be used to provide continuous control *functions*.

3.1.53 *relay*:

a *device*, whose *function* is to pass on information in an unchanged form or in some modified form, often used to mean the preferred term *computing device*.

a) *relay* is a term applied specifically to an electric, pneumatic, or hydraulic switching *device* that is actuated by a signal, and to *functions* performed by a *relay*.

3.1.54 *safety instrumented system*:

a system composed of *sensors*, logic solvers, and *final control elements* for the purpose of taking the process to a safe state when pre-determined conditions are violated.

3.1.55 *scan*:

to sample, in a predetermined manner, each of a number of variables periodically or intermittently.

a) a *scanning device* is often used to ascertain the state or value of a group of variables, and may be associated with other *functions* such as recording and *alarming*.

3.1.56 *sensor*:

a separate or integral part or *function* of a *loop* or an instrument that first senses the value of a *process variable*, that assumes a corresponding predetermined and intelligible state, and/or generates an output signal indicative of or proportional to the *process variable*; see also *detector* and *primary element*.

3.1.57 *setpoint*:

an input variable that sets the desired value of the controlled variable manually, automatically, or by means of a *program* in the same units as the controlled variable.

3.1.58 *shared control*:

a feature of a control *device* or *function* that contains a number of pre-programmed algorithms, which are user retrievable, *configurable*, and connectable, and allows user-defined control strategies or *functions* to be implemented,

a) often used to describe the control features of a *distributed control system*, *programmable logic controller*, or other microprocessor or mainframe computer based system.

b) control of multiple *process variables* can be implemented by sharing the capabilities of a single *device* of this kind.

3.1.59 shared display:

the operator interface device, a video, light-emitting diode, liquid crystal, or other display unit, used to display process control information from a number of sources at the command of the operator, often used to describe the visual features of a *distributed control system, programmable logic controller, or other microprocessor or mainframe computer based system*.

3.1.60 software:

the *programs, codes, procedures, algorithms, patterns, rules, and associated documentation* required for the operation or maintenance of microprocessor or computer systems; see also *application software*.

3.1.61 software link:

the interconnection of system components via communication networks or *functions via software or keyboard instruction*.

3.1.62 supervisory setpoint control system:

the generation of *setpoint* and/or other control information by a *computer control system* for use by *shared control, shared display* or other regulatory control *devices*.

3.1.63 switch:

a *device* that connects, disconnects, selects, or transfers one or more circuits and is not designated as a *controller, a relay, or a control valve*; the term is also applied to the *functions* performed by *switches*.

3.1.64 test point:

a process connection to which no *instrument* is permanently connected, but which is intended for the temporary or intermittent connection of an *instrument*.

3.1.65 transducer:

a general term for a *device*, which can be a *primary element, transmitter, relay, converter* or other *device*, that receives information in the form of one or more physical quantities, modifies the information or its form, or both if required, and produces a resultant output signal.

3.1.66 transmitter:

a *device* that senses a *process variable* through the medium of a *sensor* or measuring element and has an output whose steady-state value varies only as a predetermined *function* of the *process variable*.

a) the *sensor* can be an integral part, as in a direct-connected pressure *transmitter*, or a separate part, as in a thermocouple.

4 Identification letters table

4.1 Identification letters table

4.1.1 This clause provides in tabular form the alphabetic building blocks of the Instrument and Function Identification System in a concise, easily referenced manner.

4.1.2 Table 4.1, together with Clause 4.2, defines and explains the meanings of the individual letters when used to identify loop and device functions.

4.1.3 The letters in Table 4.1 shall have the mandatory meanings assigned except the user shall assign:

- a) Variables to the User's Choice letters in column 1 and functions to the User's Choice letters in columns 3, 4 and 5 when such letters are used.
- b) Meanings to the blanks in columns 2, 3, 4, and 5 when additional functions or modifiers are assigned.
- c) When such assignments are made they shall be documented in the User's engineering and design standards or guidelines and on drawing legend sheets.

4.2 Table 4.1 — Identification letters explanatory notes

The following notes, indicated in Table 4.1 by parentheses, are to be used as an aid in understanding the meanings of the letters when they are used in certain positions in Loop Identification Letter(s) or Functional Identifications.

(1) First Letters are a Measured/Initiating Variable and, if required, a combination of a Measured/Initiating Variable and a Variable Modifier that shall be referred to by the combined meaning.

(2) The specific meanings given for Measured/Initiating Variables [A], [B], [E], [F], [H], [I], [J], [K], [L], [P], [Q], [R], [S], [T], [U], [V], [W], [Y], and [Z] shall not be modified.

(3) Measured/Initiating Variable analysis [A] shall be used for all types of process stream composition and physical property analysis. The type of analyzer, and for stream component analyzers the components of interest, shall be defined outside the tagging bubble.

(a) "User's Choice" Measured/Initiating Variables [C], [D], and [M] are assigned to identify conductivity, density, and moisture analysis, respectively, when it is the user's common practice.

(4) Measured/Initiating Variable analysis [A] shall not be used to identify vibration or other types of mechanical or machinery analysis, which shall be identified by Measured/Initiating Variable vibration or mechanical analysis [V].

(5) "User's Choice" letters [C], [D], [M], [N], and [O] that cover unlisted repetitive meanings that may have one meaning as a Measured or Initiating Variable and another as a Succeeding-Letter shall be defined only once. For example, [N] may be defined as "modulus of elasticity" as a Measured/Initiating Variable and "oscilloscope" as a Readout/Passive Function.

(6) Measured/Initiating Variable multivariable [U] identifies an instrument or loop that requires multiple points of measurement or other inputs to generate single or multiple outputs, such as a PLC that uses multiple pressure and temperature measurements to regulate the switching of multiple on-off valves.

(7) Measured/Initiating Variable vibration or mechanical analysis [V] is intended to perform the function in machinery monitoring that Measured/Initiating Variable analysis [A] performs in process monitoring and except for vibration, it is expected that the variable of interest will be defined outside the tagging bubble.

(8) First-Letter or Succeeding-Letter for unclassified devices or functions [X] for non-repetitive meanings that are used only once or to a limited extent may have any number of meanings that shall be defined outside the tagging bubble or by a note in the document. For example, [XR-2] may be a stress recorder and [XX-4] may be a stress oscilloscope.

(9) Measured/Initiating Variable event, state, or presence [Y] is intended for use when control or monitoring responses are not driven by time or time schedule--but driven by events, presence, or state.

(10) Measured/Initiating Variable and Variable Modifier combinations shall be selected according to how the property being measured is modified or changed.

(11) Direct measured variables that shall be considered as Measured/Initiating Variables for Loop Numbering shall include but are not limited to:

(a) Differential [D] — pressure [PD] or temperature [TD].

(b) Total [Q] — flow totalizer [FQ], when directly measured, such as by a positive displacement flowmeter.

(c) X-axis, y-axis, or z-axis [X], [Y], or [Z] — vibration [VX], [VY], and [VZ], force [WX], [WY], or [WZ] or position [ZX], [ZY], or [ZZ].

(12) Derived or calculated from other direct measured variables that should not be considered as Measured/Initiating Variables for Loop Numbering shall include but are not limited to:

(a) Difference [D] — temperature [TD] or weight [WD].

(b) Ratio [F] — Flow [FF], pressure [PF], or temperature [TF].

(c) Time rate of change [K] — pressure [PK], temperature [TK], or weight [WK].

(13) Variable Modifier time or time schedule [K] in combination with a Measured/Initiating Variable signifies a time rate of change of the measured or initiating variable; [WK], represents a rate-of-weight-loss loop.

(14) Variable Modifier safety [S] is technically not a direct-measured variable but is used to identify self-actuated emergency protective primary and final control elements only when used in conjunction with Measured/Initiating Variables flow [F], pressure [P] or temperature [T]. And because of the critical nature of such devices, [FS, PS, and TS] shall be considered as Measured/ Initiating Variables in all Loop Identification Number construction schemes:

(a) Flow safety valve [FSV] applies to valves intended to protect against an emergency excess flow or loss of flow condition. Pressure safety valve [PSV] and temperature safety valve [TSV] apply to valves intended to protect against emergency pressure and temperature conditions. This applies regardless of whether the valve construction or mode of operation places it in the category of safety valve, relief valve, or safety relief valve.

(b) A self-actuated pressure valve that prevents operation of a fluid system at a higher-than-desired pressure by bleeding fluid from the system is a backpressure control valve [PCV], even if the valve is not intended to be used normally. However, this valve is designated a pressure

safety valve [PSV] if it protects against emergency conditions hazardous to personnel and/or equipment that are not expected to arise normally.

(c) Pressure rupture disc [PSE] and fusible link [TSE] apply to all sensors or primary elements intended to protect against emergency pressure or temperature conditions.

(d) [S] shall not be used to identify Safety Instrumented Systems and components, see (30).

(15) The grammatical form of Succeeding Letter meanings shall be modified as required; for example, 'indicate' [I] may be read as 'indicator' or 'indicating,' and 'transmit' [T] may be read as 'transmitter' or 'transmitting.'

(16) Readout/Passive Function glass, gauge, or viewing device [G] should be used instead of Readout/Passive Function indicate [I] for instruments or devices that provide a secondary view, such as level glasses, pressure gauges, thermometers, and flow sight glasses.

(a) Also used to identify devices that provide an uncalibrated view of plant operations, such as television monitors.

(17) Readout/Passive Function indicate [I] applies to the analog or digital readout of an actual measurement or input signal to a discrete instrument or a distributed control system's video display unit.

(a) In the case of a manual loader, it should be used for the dial or setting indication of the output signal being generated, [HIC] or [HIK].

(18) Readout/Passive Function scan [J] when used shall indicate a non-continuous periodic reading of two or more Measured/Initiating Variables of the same or different kinds, such as multipoint temperature and pressure recorders.

(19) Readout/Passive Function light [L] identifies devices or functions that are intended to indicate normal operating status, such as motor on-off or actuator position, and is not intended for alarm indication.

(20) Readout/Passive Function record [R] applies to any permanent or semi-permanent electronic or paper media storage of information or data in an easily retrievable form.

(21) Readout/Passive and Output/Active Function multifunction [U] is used to:

(a) Identify control loops that have more than the usual indicate/record and control functions.

(b) Save space on drawings by not showing tangent bubbles for each function.

(c) A note describing the multiple functions should be on the drawing if needed for clarity.

(22) Readout/Passive Function accessory [X] is intended to identify hardware and devices that do not measure or control but are required for the proper operation of instrumentation.

(23) There are differences in meaning to be considered when selecting between Output/Active Functions for control [C], switch [S], valve, damper, or louver [V], and auxiliary device [Y]:

(a) Control [C] means an automatic device or function that receives an input signal generated by a Measured/Initiating Variable and generates a variable output signal that is used to modulate or switch a valve [V] or auxiliary device [Y] at a predetermined setpoint for ordinary process control.

- (b) Switch [S] means a device or function that connects, disconnects, or transfers one or more air, electronic, electric, or hydraulic signals, or circuits that may be manually actuated or automatically actuated directly by a Measured or Initiating Variable, or indirectly by a Measured or Initiating Variable transmitter.
- (c) Valve, damper, or louver [V] means a device that modulates, switches, or turns on/off a process fluid stream after receiving an output signal generated by a controller [C], switch [S], or auxiliary device [Y].
- (d) Auxiliary device [Y] means an automatic device or function actuated by a controller [C], transmitter [T], or switch [S] signal that connects, disconnects, transfers, computes, and/or converts air, electronic, electric, or hydraulic signals or circuits.
- (e) The succeeding letters CV shall not be used for anything other than a self-actuated control valve.
- (24) Output/Active Function control station [K] shall be used for:
- (a) Designating an operator *accessible* control station used with an automatic controller that does not have an integral operator accessible auto-manual and/or control mode switch.
- (b) Split architecture or fieldbus control devices where the controller functions are located remotely from the operator station.
- (25) Output/Active Function auxiliary devices and functions [Y] include, but are not limited to, solenoid valves, relays, and computing and converting devices and functions
- (26) Output/Active Function auxiliary devices [Y] for signal computing and converting when shown in a diagram or drawing shall be defined outside their bubbles with an appropriate symbol from Table 5.6 Mathematical Function Blocks and when written in text shall include a description of the mathematical function from Table 5.6.
- (27) Function Modifiers high [H], low [L], and middle or intermediate [M] when applied to positions of valves and other open-close devices, are defined as follows:
- (a) High [H], the valve is in or approaching the fully open position, open [O] may be used as an alternative.
- (b) Low [L] the valve is in or approaching the fully closed position; closed [C] may be used as an alternative.
- (c) Middle or intermediate [M] the valve is traveling or located in between the fully open or closed position.
- (28) Function Modifier deviation [D] when combined with Readout/Passive Function [A] (alarm) or Output/Active Function S (switch) indicates a measured variable has deviated from a controller or other setpoint more than a predetermined amount.
- (a) Function Modifiers high [H] or low [L] shall be added if only a positive or negative deviation, respectively, is of importance.
- (29) Function Modifiers high [H], low [L], and middle or intermediate [M] when applied to alarms correspond to values of the measured variable, not to values of the alarm-actuating signal, unless otherwise noted:

- (a) A high-level alarm derived from a reverse-acting level transmitter signal is an LAH, even though the alarm is actuated when the signal falls to a low value.
 - (b) The terms shall be used in combination as appropriate to indicate multiple levels of actuation from the same measurement, for example high [H] and high-high [HH], low [L] and low-low [LL], or high-low [HL].
- (30) Variable Modifier [Z] is technically not a direct-measured variable but is used to identify the components of Safety Instrumented Systems.
- (a) [Z] shall not be used to identify the safety devices noted in (14).

Table 4.1 — Identification letters

Note: Numbers in parentheses refer to the preceding explanatory notes in Clause 4.2.

	First letters (1)		Succeeding letters (15)		
	Column 1	Column 2	Column 3	Column 4	Column 5
	Measured/Initiating Variable	Variable Modifier (10)	Readout/Passive Function	Output/Active Function	Function Modifier
A	Analysis (2)(3)(4)		Alarm		
B	Burner, Combustion (2)		User's Choice (5)	User's Choice (5)	User's Choice (5)
C	User's Choice (3a)(5)			Control (23a)(23e)	Close (27b)
D	User's Choice (3a)(5)	Difference, Differential, (11a)(12a)			Deviation (28)
E	Voltage (2)		Sensor, Primary Element		
F	Flow, Flow Rate (2)	Ratio (12b)			
G	User's Choice		Glass, Gauge, Viewing Device (16)		
H	Hand (2)				High (27a)(28a)(29)
I	Current (2)		Indicate (17)		
J	Power (2)		Scan (18)		
K	Time, Schedule (2)	Time Rate of Change (12c)(13)		Control Station (24)	
L	Level (2)		Light (19)		Low (27b)(28)(29)
M	User's Choice (3a)(5)				Middle, Intermediate (27c)(28) (29)
N	User's Choice (5)		User's Choice (5)	User's Choice (5)	User's Choice (5)
O	User's Choice (5)		Orifice, Restriction		Open (27a)
P	Pressure (2)		Point (Test Connection)		
Q	Quantity (2)	Integrate, Totalize (11b)	Integrate, Totalize		
R	Radiation (2)		Record (20)		Run
S	Speed, Frequency (2)	Safety(14)		Switch (23b)	Stop
T	Temperature (2)			Transmit	
U	Multivariable (2)(6)		Multifunction (21)	Multifunction (21)	
V	Vibration, Mechanical Analysis (2)(4)(7)			Valve, Damper, Louver (23c)(23e)	
W	Weight, Force (2)		Well, Probe		
X	Unclassified (8)	X-axis (11c)	Accessory Devices (22), Unclassified (8)	Unclassified (8)	Unclassified (8)
Y	Event, State, Presence (2)(9)	Y-axis (11c)		Auxiliary Devices (23d)(25)(26)	
Z	Position, Dimension (2)	Z-axis (11c), Safety Instrumented System (30)		Driver, Actuator, Unclassified final control element	

5 Graphic symbol tables

5.1 Graphic symbol tables

5.1.1 This clause provides in tabular form the graphic building blocks that are used to construct diagrams for measurement and control loops, instruments, and functions in a concise, easily referenced manner.

5.1.2 The graphic symbol sets included in this clause are intended to be used to prepare:

- a) Instrumentation diagrams.
- b) Functional diagrams.
- c) Binary logic diagrams.
- d) Electrical schematics.

5.1.3 The graphic symbols shown in the tables are drawn full size for use in full size sketches or drawings.

5.1.4 The device and function symbols shown in Table 5.1.1 are based on the traditional 7/16-inch or 11mm circle format but may be changed to the often-used 1/2-inch or 12mm circle format.

5.1.5 Consideration shall be given to the size of reduced P&IDs when selecting symbol sizing.

5.1.6 All symbols shall maintain the size ratios shown in the tables when reduced or increased in size.

5.2 Tables to be used for common applications

5.2.1 Instrumentation diagrams that represent instrumentation devices and functions shall be constructed from the symbols shown in:

- a) Tables 5.1.1 and 5.1.2 — Measurement and control devices or functions.
- b) Tables 5.2.1, 5.2.2, 5.2.3, and 5.2.4 — Measurement elements and transmitters.
- c) Tables 5.3.1 and 5.3.2 — Lines, instrument to process or instrument to instrument.
- d) Tables 5.4.1, 5.4.2, 5.4.3, and 5.4.4 — Final control elements.
- e) Table 5.6 — Signal processing function blocks.

5.2.2 Functional diagrams that represent monitoring and control loops shall be constructed from the symbols shown in:

- a) Table 5.5 — Functional diagramming symbols.
- b) Table 5.6 — Signal processing function block symbols.
- c) Table 5.7 — Binary logic symbols.

5.2.3 Binary logic diagrams that represent logic processes shall be constructed from the symbols shown in:

- a) Table 5.1.1 — Measurement and control devices or functions.
- b) Table 5.7 — Binary logic symbols.

5.2.4 Electrical schematics that represent electrical circuits shall be constructed from the symbols shown in:

- a) Table 5.1.1 — Measurement and control devices or functions.
- b) Table 5.8 — Electrical schematic symbols.

5.2.5 Symbols may be developed to show devices and functions not covered by this standard or to simplify the depiction of frequently used instrumentation. Such uses shall be fully detailed by sketches or notes on the drawing legend and detail sheets.

5.2.6 If new or revised symbols are developed they should be submitted to the ISA-5.1 committee for inclusion in the next revision of this standard.

5.3 Graphic symbol table explanatory notes

The following notes, indicated in Tables 5.1 through 5.8 by parentheses, shall be used as an aid in understanding the meanings of the symbols.

5.3.1 Tables 5.1.1 and 5.1.2 — Instrumentation device and function symbols:

- (1) Devices and functions that are represented by these bubble symbols are:
 - (a) Used in shared display, shared control, configurable, microprocessor-based, and data-linked instrumentation where the functions are accessible by the operator via a shared display or monitor.
 - (b) Configured in control systems that include, but are not limited to, distributed control systems (DCS), programmable logic controllers (PLC), personal computers (PC), and intelligent transmitters and valve positioners.
- (2) The user shall select and document one of the following for use of these symbols in a:
 - (a) Primary shared-display, shared-control system.
 - (b) Basic Process Control System (BPCS).
- (3) The user shall select and document one of the following for use of these symbols in an:
 - (a) Alternate shared-display, shared-control system.
 - (b) Safety Instrumented System (SIS).
- (4) Devices and functions represented by these bubble symbols are configured in computer systems that include, but are not limited to:

- (a) Process controllers, process optimizers, statistical process control, model-predictive process control, analyzer controllers, business computers, manufacturing execution systems, and other systems that interact with the process by manipulating setpoints in the BPCS.
 - (b) High Level Control System (HLCS)
- (5) Discrete devices or functions that are hardware-based and are either stand-alone or are connected to other instruments, devices, or systems that include, but are not limited to, transmitters, switches, relays, controllers, and control valves.
- (6) Accessibility includes viewing, setpoint adjustment, operating mode changing, and any other operator actions required to operate the instrumentation.
- (7) Functions represented by these symbols are used for simple interlock logic:
- (a) A description of the logic should be shown nearby or in the notes section of the drawing or sketch if the intended logic is not clearly understandable.
 - (b) These symbols are not recommended for depicting complex DCS, PLC, or SIS applications that require other than 'AND' and 'OR' signal gates.
- (8) A logic number, letter, or number/letter combination identification shall be used if more than one logic scheme is used on the project by:
- (a) Replacing [I], [A], and [O] with the logic identification.
 - (b) Appending the logic identification outside the symbol.

5.3.2 Tables 5.2.1, 5.2.2, 5.2.3, 5.2.4, and 5.2.5 — Measurement symbols

- (1) Measurements are depicted by:
- (a) Bubbles only.
 - (b) Bubbles and graphics.
- (2) These symbols shall be used for process or equipment measurements if:
- (a) A graphic symbol does not exist.
 - (b) The user does not use graphic symbols.
- (3) Transmitter [T] may be controller [C], indicator [I], recorder [R], or switch [S].
- (4) User engineering and design standards, practices, and/or guidelines shall document which choices are selected.

5.3.3 Tables 5.3.1 and 5.3.2 — Line symbols:

- (1) Power supplies shall be shown when:
- (a) Different from those normally used, e.g., 120 Vdc when normal is 24 Vdc.
 - (b) When a device requires an independent power supply.

- (c) Affected by controller or switch actions.
- (2) Arrows shall be used if needed to clarify direction of signal flow.
- (3) Users engineering and design standards, practices and/or guidelines shall document which symbol has been selected.
- (4) The line symbols connect devices and functions that are integral parts of dedicated systems, such as distributed control systems (DCS), programmable logic controllers (PLC), personal computer systems (PC), and computer control systems (CCS) over a dedicated communication link.
- (5) The line symbols connect independent microprocessor-based and computer-based systems to each other over a dedicated communications link, using but not limited to the RS232 protocol.
- (6) The line symbols connect “intelligent” devices, such as microprocessor-based transmitters and control valve positioners that contain control functionality, to other such devices and to the instrumentation system, using but not limited to Ethernet fieldbus protocols.
- (7) The line symbols connect “smart” devices, such as transmitters, to instrumentation system input signal terminals and provide a superimposed digital signal that is used for instrument diagnostics and calibration.

5.3.4 Tables 5.4.1, 5.4.2, 5.4.3 and 5.4.4 — Final control element symbols:

- (1) Users engineering and design standards, practices, and/or guidelines shall document which symbols have been selected.
- (2) Element symbols 1 through 14, when combined with actuator symbols 1 through 16, represent process control valves.
- (3) Element symbol 2, when combined with actuator symbols 20 and 21, represent pressure safety valves.
- (4) Element symbols 15 through 19, when combined with actuator symbols 13, 14, and 15, represent on-off solenoid valves.
- (5) Element symbol 21, when combined with actuator symbols 1 through 16, represents a variable speed control unit.
- (6) Element symbol 21 represents a motor that manipulates or controls a process variable.
- (7) Actuator symbols 1 through 16, when combined with element symbols 1 through 14, represent process control valves and with element symbol 21 represents a variable speed control unit.
- (8) Actuator symbols 17, 18, and 19, when combined with element symbols 15 through 19, represent on-off solenoid valves.
- (9) Actuator symbols 20 and 21, when combined with element symbol 2, represent pressure safety valves.
- (10) The symbols are applicable to all types of control valves and actuators.

5.3.5 Table 5.5 — Functional diagramming symbols:

- (1) Signal flow is assumed to be from top-to-bottom or from left-to-right.

- (2) Symbols are shown in a vertical diagram format.
- (3) Symbols shall be rotated 90 degrees counterclockwise in a horizontal diagram format.
- (4) Insert signal processing symbol from Table 5.6 at (*).

5.3.6 Table 5.6 — Signal processing function block symbols:

- (1) Symbols in small squares and rectangles are as used with symbol #1 from Table 5.1.2.
- (2) Symbols in large rectangles are as used with symbol #5 from Table 5.5.
- (3) Users engineering and design standards, practices and/or guidelines shall document which symbol has been selected.

5.3.7 Table 5.7 — Binary logic symbols:

- (1) True signals are equal to binary one, and false signals are equal to binary zero.
- (2) Alternate symbols shall be used only for “AND” and “OR” gates.
- (3) Users engineering and design standards, practices and/or guidelines shall document which symbol has been selected.

5.3.8 Table 5.8 — Electrical schematic symbols

- (1) All devices are shown in the unactuated or de-energized condition.
- (2) Switch contacts 2, 3, and 4 shall be actuated by:
 - (a) Hand.
 - (b) Actuator symbols 5 and 6.
- (3) Actuator symbols 5 and 6 shall actuate switch symbols 2, 3, and 4.
- (4) Switch symbols 7, 8, and 9 shall be actuated by:
 - (a) Hand.
 - (b) Actuator symbols 11 through 16.
 - (c) Bubble symbol for device or function assigned to actuate the switch symbol.
- (5) Actuator symbols 11 through 16 shall actuate switch symbols 7, 8, and 9.
- (6) Users engineering and design standards, practices and/or guidelines shall document which symbol has been selected.

Table 5.1.1 — Instrumentation device and function symbols

Note: Numbers in parentheses refer to explanatory notes in Clause 5.3.1.





















No.	Shared display, Shared control (1)		C	D	Location & accessibility (6)
	A	B			
	Primary Choice or Basic Process Control System (2)	Alternate Choice or Safety Instrumented System (3)	Computer Systems and Software (4)	Discrete (5)	
1					<ul style="list-style-type: none"> • Located in field. • Not panel, cabinet, or console mounted. • Visible at field location. • Normally operator accessible.
2					<ul style="list-style-type: none"> • Located in or on front of central or main panel or console. • Visible on front of panel or on video display. • Normally operator accessible at panel front or console.
3					<ul style="list-style-type: none"> • Located in rear of central or main panel. • Located in cabinet behind panel. • Not visible on front of panel or on video display. • Not normally operator accessible at panel or console.
4					<ul style="list-style-type: none"> • Located in or on front of secondary or local panel or console. • Visible on front of panel or on video display. • Normally operator accessible at panel front or console.
5					<ul style="list-style-type: none"> • Located in rear of secondary or local panel. • Located in field cabinet. • Not visible on front of panel or on video display. • Not normally operator accessible at panel or console.

Table 5.1.2 — Instrumentation device or function symbols, miscellaneous

Note: Numbers in parentheses refer to explanatory notes in Clause 5.3.1.





No	Symbol	Description
1		<ul style="list-style-type: none"> • Signal processing function: • Locate in upper right or left quadrant of symbols above. • Attach to symbols above where affected signals are connected. • Insert signal processing symbol from Table 5.6 • Expand symbol by 50% increments for larger function symbols.
2		<ul style="list-style-type: none"> • Panel-mounted patchboard plug-in point. • Console matrix point. • C-12 equals patchboard column and row respectively, as an example.
3	(7) (8) 	<ul style="list-style-type: none"> • Generic interlock logic function. • Undefined interlock logic function.
4	(7) (8) 	<ul style="list-style-type: none"> • 'AND' interlock logic function.
5	(7) (8) 	<ul style="list-style-type: none"> • 'OR' interlock logic function.
6		<ul style="list-style-type: none"> • Instruments or functions sharing a common housing. • It is not mandatory to show a common housing. • Notes shall be used to identify instruments in common housings not using this symbol.
7		<ul style="list-style-type: none"> • Pilot light. • Circle shall be replaced with any symbol from column D in Table 5.1.1 if location and accessibility needs to be shown.

Table 5.2.1 — Measurement symbols: primary elements and transmitters

Note: Numbers in parentheses refer to explanatory notes in Clause 5.3.2.

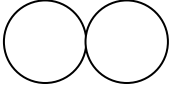
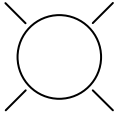

No	Symbol	Description
1	(1a) (2) 	<ul style="list-style-type: none"> • Generic primary element, bubble format. • Notation (*) from Table 5.2.2 should be used to identify type of element. • Connect to process or other instruments by symbols from Tables 5.3.1 and 5.3.2. • Insert in or on process flow line, vessel, or equipment.
2	(1a) (2) (3) 	<ul style="list-style-type: none"> • Transmitter with integral primary element, bubble format. • Notation (*) from Table 5.2.2 should be used to identify type of element. • Connect to process or other instruments by symbols from Tables 5.3.1 and 5.3.2. • Insert in or on process flow line, vessel, or equipment.
3	(1a) (2) (3) 	<ul style="list-style-type: none"> • Transmitter with close coupled primary element, bubble format • Notation (*) from Table 5.2.2 should be used to identify type of element. • Connecting line shall be equal to or less than 0.25 inches (6 millimeters). • Connect to process or other instruments by symbols from Tables 5.3.1 and 5.3.2. • Insert element in or on process flow line, vessel, or equipment.
4	(1a) (3) 	<ul style="list-style-type: none"> • Transmitter with remote primary element, bubble format. • Notation (*) from Table 5.2.2 should be used to identify type of element. • Connecting line shall be equal to or greater than 0.5 inches (12 millimeters). • Connect to process or other instruments by symbols from Tables 5.3.1 and 5.3.2. • Insert element in or on process flow line, vessel, or equipment.
5	(1b) (3) 	<ul style="list-style-type: none"> • Transmitter with integral primary element inserted in or on process flow line, vessel, or equipment, bubble/graphic format. • Insert primary element symbol from Table 5.2.3 at #. • Connect to other instruments by symbols from Table 5.3.2.
6	(1b) (3) 	<ul style="list-style-type: none"> • Transmitter with close-coupled primary element inserted in or on process flow line, vessel, or equipment, bubble/graphic format. • Insert primary element symbol from Table 5.2.3 at #. • Connecting line shall be equal to or less than 0.25 inches (6 millimeters). • Connect to other instruments by symbols from Table 5.3.2.
7	(1b) (3) 	<ul style="list-style-type: none"> • Transmitter with remote primary element inserted in or on process flow line, vessel, or equipment, bubble/graphic format. • Insert primary element symbol from Table 5.2.3 at #. • Connecting line may be any signal line from Table 5.2.3. • Connecting line shall be equal to or greater than 0.5 inches (12 millimeters). • Connect to other instruments by symbols from Table 5.3.2.

Table 5.2.2 — Measurement symbols: measurement notations (4)

Note: Numbers in parentheses refer to explanatory notes in Clause 5.3.2

Analysis			
AIR = Excess air	H2O = Water	O2 = Oxygen	UV = Ultraviolet
CO = Carbon monoxide	H2S = Hydrogen sulfide	OP = Opacity	VIS = Visible light
CO2 = Carbon dioxide	HUM = Humidity	ORP = Oxidation reduction	VISC = Viscosity
COL = Color	IR = Infrared	pH = Hydrogen ion	=
COMB = Combustibles	LC = Liquid chromatograph	REF = Refractometer	=
COND = Elec. conductivity	MOIST = Moisture	RI = Refractive index	=
DEN = Density	MS = Mass spectrometer	TC = Thermal conductivity	=
GC = Gas chromatograph	NIR = Near infrared	TDL = Tunable diode laser	=
Flow			
CFR = Constant flow regulator	OP = Orifice plate	PT = Pitot tube	VENT = Venturi tube
CONE = Cone	OP-CT = Corner taps	PV = Pitot venturi	VOR = Vortex Shedding
COR = Coriolis	OP-CQ = Circle quadrant	SNR = Sonar	WDG = Wedge
DOP = Doppler	OP-E = Eccentric	SON = Sonic	=
DSON = Doppler sonic	OP-FT = Flange taps	TAR = Target	=
FLN = Flow nozzle	OP-MH = Multi-hole	THER = Thermal	=
FLT = Flow tube	OP-P = Pipe taps	TTS = Transit time sonic	=
LAM = Laminar	OP-VC = Vena contracta taps	TUR = Turbine	=
MAG = Magnetic	PD = Positive displacement	US = Ultrasonic	=
Level			
CAP = Capacitance	GWR = Guided wave radar	NUC = Nuclear	US = Ultrasonic
d/p = Differential pressure	LSR = Laser	RAD = Radar	=
DI = Dielectric constant	MAG = Magnetic	RES = Resistance	=
DP = Differential pressure	MS = Magnetostrictive	SON = Sonic	=
Pressure			
ABS = Absolute	MAN = Manometer	VAC = Vacuum	=
AVG = Average	P-V = Pressure-vacuum	=	=
DRF = Draft	SG = Strain gage	=	=
Temperature			
BM = Bi-metallic	RTD = Resistance temp detector	TCK = Thermocouple type K	TRAN = Transistor
IR = Infrared	TC = Thermocouple	TCT = Thermocouple type T	=
RAD = Radiation	TCE = Thermocouple type E	THRM = Thermistor	=
RP = Radiation pyrometer	TCJ = Thermocouple type J	TMP = Thermopile	=
Miscellaneous			
Burner, Combustion	Position	Quantity	Radiation
FR = Flame rod	CAP = Capacitance	PE = Photoelectric	α = Alpha radiation
IGN = Igniter	EC = Eddy current	TOG = Toggle	β = Beta radiation
IR = Infrared	IND = Inductive	=	γ = Gamma radiation
TV = Television	LAS = Laser	=	n = Neutron radiation
UV = Ultraviolet	MAG = Magnetic	=	=
=	MECH = Mechanical	=	=
=	OPT = Optical	=	=
=	RAD = Radar	=	=
=	=	=	=
Speed	Weight, Force		
ACC = Acceleration	LC = Load cell	=	=
EC = Eddy current	SG = Strain gauge	=	=
PROX = Proximity	WS = Weigh scale	=	=
VEL = Velocity	=	=	=
=	=	=	=

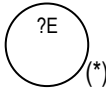
Table 5.2.3 — Measurement symbols: primary elements

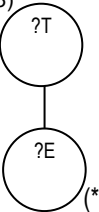
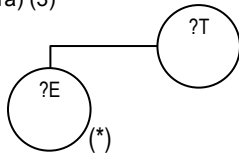
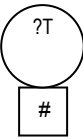
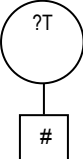
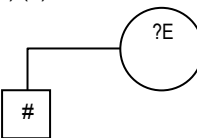
Note: Numbers in parentheses refer to explanatory notes in Clause 5.3.2.















No		Symbol (4)	Description
Analysis	1		<ul style="list-style-type: none"> Conductivity, moisture, etc. Single element sensing probe.
Analysis	2		<ul style="list-style-type: none"> pH, ORP, etc. Dual element sensing probe.
Analysis	3		<ul style="list-style-type: none"> Fiberoptic sensing probe.
Burner	4		<ul style="list-style-type: none"> Ultraviolet flame detector. Television flame monitor.
Burner	5		<ul style="list-style-type: none"> Flame rod flame detector.
Flow	6		<ul style="list-style-type: none"> Generic orifice plate. Restriction orifice.
Flow	7		<ul style="list-style-type: none"> Orifice plate in quick-change fitting.
Flow	8		<ul style="list-style-type: none"> Concentric circle orifice plate. Restriction orifice.
Flow	9		<ul style="list-style-type: none"> Eccentric circle orifice plate.
Flow	10		<ul style="list-style-type: none"> Circle quadrant orifice plate.
Flow	11		<ul style="list-style-type: none"> Multi-hole orifice plate
Flow	12		<ul style="list-style-type: none"> Generic venturi tube, flow nozzle, or flow tube. Notation from Table 5.2.2 required at (*) if used for more than one type.
Flow	13		<ul style="list-style-type: none"> Venturi tube.
Flow	14		<ul style="list-style-type: none"> Flow nozzle.
Flow	15		<ul style="list-style-type: none"> Flow tube.

Table 5.2.3 — Measurement symbols: primary elements

Note: Numbers in parentheses refer to explanatory notes in Clause 5.3.2.

















No		Symbol (4)	Description
Flow	16		<ul style="list-style-type: none"> Integral orifice plate.
Flow	17		<ul style="list-style-type: none"> Standard pitot tube.
Flow	18		<ul style="list-style-type: none"> Averaging pitot tube.
Flow	19		<ul style="list-style-type: none"> Turbine flowmeter. Propeller flowmeter.
Flow	20		<ul style="list-style-type: none"> Vortex shedding flowmeter
Flow	21		<ul style="list-style-type: none"> Target flowmeter.
Flow	22	(4) a)  b) 	<ul style="list-style-type: none"> Magnetic flowmeter.
Flow	23	(4) a)  b) 	<ul style="list-style-type: none"> Thermal mass flowmeter.
Flow	24		<ul style="list-style-type: none"> Positive displacement flowmeter.
Flow	25		<ul style="list-style-type: none"> Cone meter. Annular orifice meter.
Flow	26		<ul style="list-style-type: none"> Wedge meter.
Flow	27		<ul style="list-style-type: none"> Coriolis flowmeter.
Flow	28		<ul style="list-style-type: none"> Sonic flowmeter. Ultrasonic flowmeter.
Flow	29		<ul style="list-style-type: none"> Variable area flowmeter.
Flow	30		<ul style="list-style-type: none"> Open channel weir plate.

Table 5.2.3 — Measurement symbols: primary elements

Note: Numbers in parentheses refer to explanatory notes in Clause 5.3.2.







No		Symbol (4)	Description
Flow	31		<ul style="list-style-type: none"> Open channel flume.
Level	32		<ul style="list-style-type: none"> Displacer internally mounted in vessel.
Level	33		<ul style="list-style-type: none"> Ball float internally mounted in vessel. May be installed through top of vessel.
Level	34		<ul style="list-style-type: none"> Radiation, single point. Sonic.
Level	35		<ul style="list-style-type: none"> Radiation, multi-point or continuous.
Level	36		<ul style="list-style-type: none"> Dip tube or other primary element and stilling well. May be installed through side of vessel. May be installed without stilling well.
Level	37		<ul style="list-style-type: none"> Float with guide wires. Location of readout should be noted, at grade, at top, or accessible from a ladder. Guide wires may be omitted.
Level	38		<ul style="list-style-type: none"> Insert probe. May be through top of vessel.
Level	39		<ul style="list-style-type: none"> Radar.
Pressure	40		<ul style="list-style-type: none"> Strain gage or other electronic type sensor. Notation (*) from Table 5.2.2 should be used to identify type of element. Connection symbols 6, 7, 8, or 9 in Table 5.3.1 are used if connection type is to be shown. Bubble may be omitted if connected to another instrument.

Table 5.2.3 — Measurement symbols: primary elements

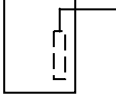
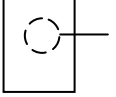
Note: Numbers in parentheses refer to explanatory notes in Clause 5.3.2.

No		Symbol (4)	Description
Temperature	41		<ul style="list-style-type: none"> • Generic element without thermowell. • Notation (*) should be used to identify type of element, see Table 5.2.2. • Connection symbols 6, 7, 8, or 9 in Table 5.3.1 are used if connection type is to be shown. • Bubble may be omitted if connected to another instrument.

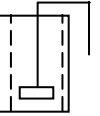
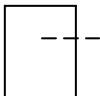
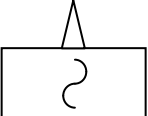
Table 5.2.4 — Measurement symbols: secondary instruments

Note: Numbers in parentheses refer to explanatory notes in Clause 5.3.2.

No		Symbol (4)	Description
Flow	1		<ul style="list-style-type: none"> • Sight glass.
Level	2		<ul style="list-style-type: none"> • Gage integrally mounted on vessel. • Sight glass.
Level	3		<ul style="list-style-type: none"> • Gage glass externally mounted on vessel or standpipe. • Multiple gages may be shown as one bubble or one bubble for each section. • Use connection 6, 7, 8, or 9 in Table 5.3.1 if connection type is to be shown.
Pressure	4		<ul style="list-style-type: none"> • Pressure gage. • Use connection 6, 7, 8, or 9 in Table 5.3.1 if connection type is to be shown.
Temperature	5		<ul style="list-style-type: none"> • Thermometer. • Use connection 6, 7, 8, or 9 in Table 5.3.1 if connection type is to be shown.

Table 5.2.5 — Measurement symbols: auxiliary and accessory devices

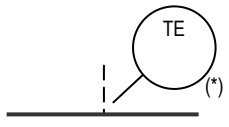
Note: Numbers in parentheses refer to explanatory notes in Clause 5.3.2.

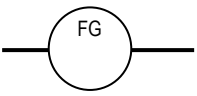
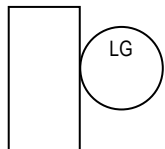
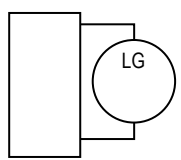
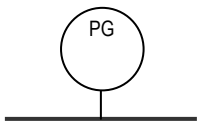
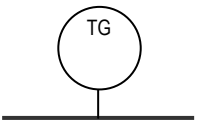

	No	Symbol (4)	Description
Analysis	1		<ul style="list-style-type: none"> • Sample insert probe, flanged. • Sample well, flanged. • Use connection 7, 8, or 9 in Table 5.3.1 if flange is not used.
Analysis	2		<ul style="list-style-type: none"> • Sample conditioner or other analysis accessory, flanged. • Represents single or multiple devices. • Use connection 7, 8, or 9 in Table 5.3.1 if flange is not used.
Flow	3		<ul style="list-style-type: none"> • Flow straightening vanes. • Flow conditioning element.
Flow	4		<ul style="list-style-type: none"> • Instrument purge or flushing fluid. • Instrument purge or flushing device or devices. • Show assembly details on drawing legend sheet.
Pressure	5		<ul style="list-style-type: none"> • Diaphragm pressure seal, flanged, threaded, socket welded, or welded. • Diaphragm chemical seal, flanged, threaded, socket welded, or welded. • Use connection 6, 7, 8, or 9 in Table 5.3.1 if connection type is to be shown.
Pressure	6		<ul style="list-style-type: none"> • Diaphragm pressure seal, welded. • Diaphragm chemical seal, welded.
Temperature	7		<ul style="list-style-type: none"> • Thermowell, flanged. • Test well, flanged. • Bubble may be omitted if connected to another instrument. • Use connection 7, 8, or 9 in Table 5.3.1 if flange is not used.

Table 5.3.1 — Line symbols: instrument to process and equipment connections

Note: Numbers in parentheses refer to explanatory notes in Clause 5.3.3.



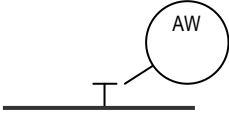
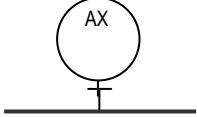
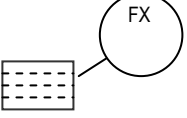

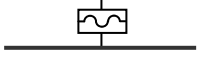
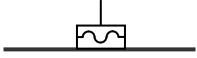
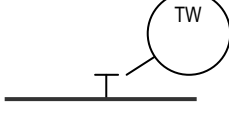

No	Symbol	Application
1		<ul style="list-style-type: none"> • Instrument connections to process and equipment. • Process impulse lines. • Analyzer sample lines.
2		<ul style="list-style-type: none"> • Heat [cool] traced impulse or sample line from process. • Type of tracing indicated by: [ET] electrical, [ST] steam, [CW] chilled water, etc.
3		<ul style="list-style-type: none"> • Generic instrument connection to process line. • Generic instrument connection to equipment.
4		<ul style="list-style-type: none"> • Heat [cool] traced generic instrument impulse line. • Process line or equipment may or may not be traced.
5		<ul style="list-style-type: none"> • Heat [cool] traced instrument. • Instrument impulse line may or may not be traced.
6		<ul style="list-style-type: none"> • Flanged instrument connection to process line. • Flanged instrument connection to equipment.
7		<ul style="list-style-type: none"> • Threaded instrument connection to process line. • Threaded instrument connection to equipment.
8		<ul style="list-style-type: none"> • Socket welded instrument connection to process line. • Socket welded instrument connection to equipment.
9		<ul style="list-style-type: none"> • Welded instrument connection to process line. • Welded instrument connection to equipment.

Table 5.3.2 — Line symbols: instrument-to-instrument connections

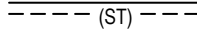
Note: Numbers in parentheses refer to explanatory notes in Clause 5.3.3.

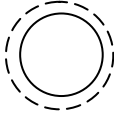
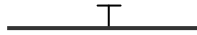





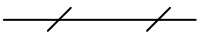

No	Symbol	Application
1	(1) IA _____	<ul style="list-style-type: none"> IA may be replaced by PA [plant air], NS [nitrogen], or GS [any gas supply]. Indicate supply pressure as required, e.g., PA-70 kPa, NS-150 psig, etc.
2	(1) ES _____	<ul style="list-style-type: none"> Instrument electric power supply. Indicate voltage and type as required, e.g. ES-220 Vac. ES may be replaced by 24 Vdc, 120 Vac, etc.
3	(1) HS _____	<ul style="list-style-type: none"> Instrument hydraulic power supply. Indicate pressure as required, e.g., HS-70 psig.
4	(2) 	<ul style="list-style-type: none"> Undefined signal. Use for Process Flow Diagrams. Use for discussions or diagrams where type of signal is not of concern.
5	(2) 	<ul style="list-style-type: none"> Pneumatic signal, continuously variable or binary.
6	(2) -----	<ul style="list-style-type: none"> Electronic or electrical continuously variable or binary signal. Functional diagram binary signal.
7	(2) _____	<ul style="list-style-type: none"> Functional diagram continuously variable signal. Electrical schematic ladder diagram signal and power rails.
8	(2) 	<ul style="list-style-type: none"> Hydraulic signal.
9	(2) 	<ul style="list-style-type: none"> Filled thermal element capillary tube. Filled sensing line between pressure seal and instrument.
10	(2) 	<ul style="list-style-type: none"> Guided electromagnetic signal. Guided sonic signal. Fiber optic cable.
11	(3) a)   b)  	<ul style="list-style-type: none"> Unguided electromagnetic signals, light, radiation, radio, sound, wireless, etc. Wireless instrumentation signal. Wireless communication link.
12	(4) —○—○—	<ul style="list-style-type: none"> Communication link and system bus, between devices and functions of a shared display, shared control system. DCS, PLC, or PC communication link and system bus.
13	(5) —●—●—	<ul style="list-style-type: none"> Communication link or bus connecting two or more independent microprocessor or computer-based systems. DCS-to-DCS, DCS-to-PLC, PLC-to-PC, DCS-to-Fieldbus, etc. connections.
14	(6) —◇—◇—	<ul style="list-style-type: none"> Communication link and system bus, between devices and functions of a fieldbus system. Link from and to "intelligent" devices.
15	(7) --○--○--	<ul style="list-style-type: none"> Communication link between a device and a remote calibration adjustment device or system. Link from and to "smart" devices.

Table 5.3.2 — Line symbols: instrument-to-instrument connections

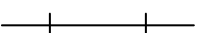
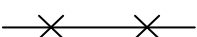
Note: Numbers in parentheses refer to explanatory notes in Clause 5.3.3.







No	Symbol	Application
16		<ul style="list-style-type: none"> Mechanical link or connection.
17	<p>(3)</p> <p>a) </p> <p>a) </p> <p>b) </p> <p>b) </p>	<ul style="list-style-type: none"> Drawing-to-drawing signal connector, signal flow from left to right. (#) = Instrument tag number sending or receiving signal. (##) = Drawing or sheet number receiving or sending signal.
18		<ul style="list-style-type: none"> Signal input to logic diagram. (*) = Input description, source, or instrument tag number.
19		<ul style="list-style-type: none"> Signal output from logic diagram. (*) = Output description, destination, or instrument tag number.
20		<ul style="list-style-type: none"> Internal functional, logic, or ladder diagram signal connector. Signal source to one or more signal receivers. (*) = Connection identifier A, B, C, etc.
21		<ul style="list-style-type: none"> Internal functional, logic, or ladder diagram signal connector. Signal receiver, one or more from a single source. (*) = Connection identifier A, B, C, etc.

Table 5.4.1 — Final control element symbols

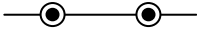
Note: Numbers in parentheses refer to explanatory notes in Clause 5.3.4.

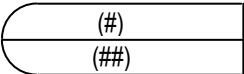

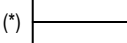
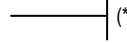
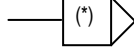





No	Symbol	Description
1	(1) (2) a)  b) 	<ul style="list-style-type: none"> • Generic two-way valve. • Straight globe valve. • Gate valve.
2	(2) (3) 	<ul style="list-style-type: none"> • Generic two-way angle valve. • Angle globe valve. • Safety angle valve.
3	(2) 	<ul style="list-style-type: none"> • Generic three-way valve. • Three-way globe valve. • Arrow indicates failure or unactuated flow path.
4	(2) 	<ul style="list-style-type: none"> • Generic four-way valve. • Four-way four-ported plug or ball valve. • Arrows indicates failure or unactuated flow paths.
5	(2) 	<ul style="list-style-type: none"> • Butterfly valve.
6	(2) 	<ul style="list-style-type: none"> • Ball valve.
7	(2) 	<ul style="list-style-type: none"> • Plug valve
8	(2) 	<ul style="list-style-type: none"> • Eccentric rotary disc valve.
9	(1) (2) a)  b) 	<ul style="list-style-type: none"> • Diaphragm valve.
10	(2) 	<ul style="list-style-type: none"> • Pinch valve.
11	(2) 	<ul style="list-style-type: none"> • Bellows sealed valve.
12	(2) 	<ul style="list-style-type: none"> • Generic damper. • Generic louver.
13	(2) 	<ul style="list-style-type: none"> • Parallel blade damper. • Parallel blade louver.
14	(2) 	<ul style="list-style-type: none"> • Opposed blade damper. • Opposed blade louver.

Table 5.4.1 — Final control element symbols

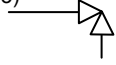
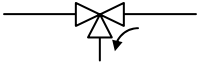
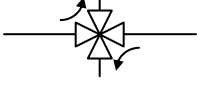
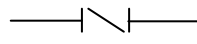
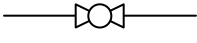
Note: Numbers in parentheses refer to explanatory notes in Clause 5.3.4.

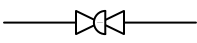

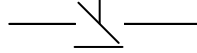
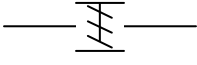
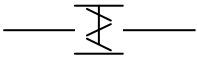

No	Symbol	Description
15	(4) 	<ul style="list-style-type: none"> Two-way on-off solenoid valve.
16	(4) 	<ul style="list-style-type: none"> Angle on-off solenoid valve.
17	(4) 	<ul style="list-style-type: none"> Three-way on-off solenoid valve. Arrow indicates de-energized flow path.
18	(4) 	<ul style="list-style-type: none"> Four-way plug or ball on-off solenoid valve. Arrows indicates de-energized flow paths.
19	(4) 	<ul style="list-style-type: none"> Four-way five-ported on-off solenoid valve. Arrows indicates de-energized flow paths.
20	(5) 	<ul style="list-style-type: none"> Permanent magnet variable speed coupling.
21	(6) 	<ul style="list-style-type: none"> Electric motor.

Table 5.4.2 — Final control element actuator symbols

Note: Numbers in parentheses refer to explanatory notes in Clause 5.3.4

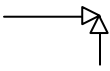
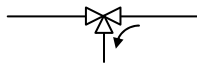







No	Symbol	Description
1	(7) 	<ul style="list-style-type: none"> • Generic actuator. • Spring-diaphragm actuator.
2	(7) 	<ul style="list-style-type: none"> • Spring-diaphragm actuator with positioner.
3	(7) 	<ul style="list-style-type: none"> • Pressure-balanced diaphragm actuator.
4	(7) 	<ul style="list-style-type: none"> • Linear piston actuator. • Single acting spring opposed • Double acting.
5	(7) 	<ul style="list-style-type: none"> • Linear piston actuator with positioner.
6	(7) 	<ul style="list-style-type: none"> • Rotary piston actuator. • May be single acting spring opposed or double acting.
7	(7) 	<ul style="list-style-type: none"> • Rotary piston actuator with positioner.
8	(7) 	<ul style="list-style-type: none"> • Bellows spring opposed actuator.
9	(7) 	<ul style="list-style-type: none"> • Rotary motor operated actuator. • Electric, pneumatic, or hydraulic. • Linear or rotary action.
10	(7) 	<ul style="list-style-type: none"> • Modulating solenoid actuator. • Solenoid actuator for process on-off valve.
11	(7) 	<ul style="list-style-type: none"> • Actuator with side-mounted handwheel.

Table 5.4.2 — Final control element actuator symbols

Note: Numbers in parentheses refer to explanatory notes in Clause 5.3.4

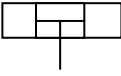
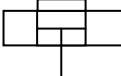









No	Symbol	Description
12	(7) 	<ul style="list-style-type: none"> Actuator with top-mounted handwheel.
13	(7) 	<ul style="list-style-type: none"> Manual actuator. Hand actuator.
14	(7) 	<ul style="list-style-type: none"> Electrohydraulic linear or rotary actuator.
15	(7) 	<ul style="list-style-type: none"> Actuator with manual actuated partial stroke test device.
16	(7) 	<ul style="list-style-type: none"> Actuator with remote actuated partial stroke test device.
17	(8) 	<ul style="list-style-type: none"> Automatic reset on-off solenoid actuator. Non-latching on-off solenoid actuator.
18	(8) 	<ul style="list-style-type: none"> Manual or remote reset on-off solenoid actuator. Latching on-off solenoid actuator.
19	(8) 	<ul style="list-style-type: none"> Manual and remote reset on-off solenoid actuator. Latching on-off solenoid actuator.
20	(9) 	<ul style="list-style-type: none"> Spring or weight actuated relief or safety valve actuator.
21	(9) 	<ul style="list-style-type: none"> Pilot actuated relief or safety valve actuator. Pilot pressure sensing line deleted if sensing is internal.

Table 5.4.3 — Self-actuated final control element symbol

Note: Numbers in parentheses refer to explanatory notes in Clause 5.3.4.

No	Symbol	Description
1		<ul style="list-style-type: none"> Automatic flow regulator. XXX = FCV without indicator. XXX = FICV with integral indicator.
2	<p>(1) (2)</p> <p>(a) </p> <p>(b) </p>	<ul style="list-style-type: none"> Variable area flowmeter with integral manual adjusting valve. Instrument tag bubble required with (b).
3		<ul style="list-style-type: none"> Constant flow regulator.
4		<ul style="list-style-type: none"> Flow sight glass. Type shall be noted if more than one type used.
5		<ul style="list-style-type: none"> Generic flow restriction. Single stage orifice plate as shown. Note required for multi-stage or capillary tube types.
6		<ul style="list-style-type: none"> Restriction orifice hole drilled in valve plug. Tag number shall be omitted if valve is otherwise identified.
7		<ul style="list-style-type: none"> Level regulator. Ball float and mechanical linkage.
8		<ul style="list-style-type: none"> Backpressure regulator. Internal pressure tap.
9		<ul style="list-style-type: none"> Backpressure regulator. External pressure tap.

Table 5.4.3 — Self-actuated final control element symbol

Note: Numbers in parentheses refer to explanatory notes in Clause 5.3.4.

No	Symbol	Description
10		<ul style="list-style-type: none"> • Pressure-reducing regulator. • Internal pressure tap.
11		<ul style="list-style-type: none"> • Pressure-reducing regulator. • External pressure tap.
12		<ul style="list-style-type: none"> • Differential pressure regulator. • External pressure taps.
13		<ul style="list-style-type: none"> • Differential pressure regulator. • Internal pressure taps.
14		<ul style="list-style-type: none"> • Pressure-reducing regulator w/ integral outlet pressure relief and pressure gauge.
15		<ul style="list-style-type: none"> • Generic pressure safety valve. • Pressure relief valve.
16		<ul style="list-style-type: none"> • Generic vacuum safety valve. • Vacuum relief valve.
17		<ul style="list-style-type: none"> • Generic pressure - vacuum relief valve. • Tank pressure - vacuum relief valve.
18		<ul style="list-style-type: none"> • Pressure safety element. • Pressure rupture disk. • Pressure relief.
19		<ul style="list-style-type: none"> • Pressure safety element. • Vacuum rupture disk. • Vacuum relief.

Table 5.4.3 — Self-actuated final control element symbol

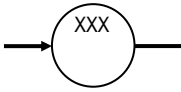
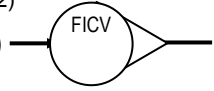
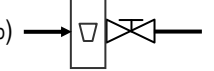
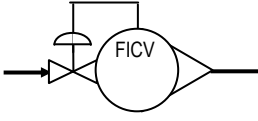
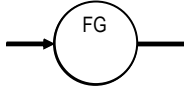
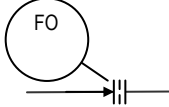
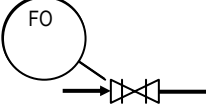
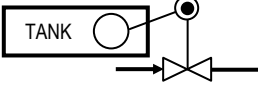
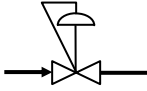
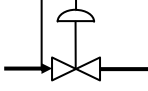
Note: Numbers in parentheses refer to explanatory notes in Clause 5.3.4.

No	Symbol	Description
20		<ul style="list-style-type: none"> • Temperature regulator. • Filled thermal system.
21		<ul style="list-style-type: none"> • Thermal safety element. • Fusible plug or disk.
22		<ul style="list-style-type: none"> • Generic moisture trap. • Steam trap. • Note required for other trap types.
23		<ul style="list-style-type: none"> • Moisture trap with equalizing line.

Table 5.4.4 — Control valve failure and de-energized position indications

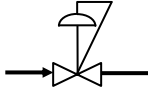
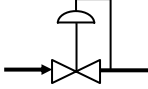
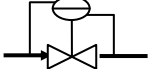
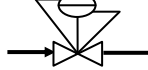
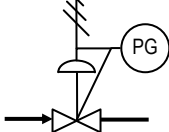
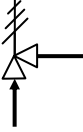
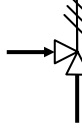
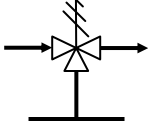
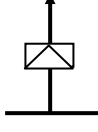
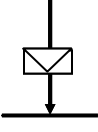
Note: Numbers in parentheses refer to explanatory notes in Clause 5.3.4.





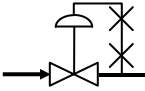
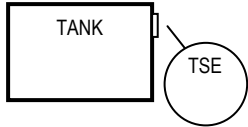
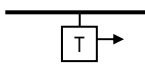
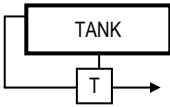





No	Method A (1) (10)	Method B (1) (10)	Definition
1			<ul style="list-style-type: none"> Fail to open position.
2			<ul style="list-style-type: none"> Fail to closed position.
3			<ul style="list-style-type: none"> Fail locked in last position.
4			<ul style="list-style-type: none"> Fail at last position. Drift open.
5			<ul style="list-style-type: none"> Fail at last position. Drift closed.

Table 5.5 — Functional diagramming symbols

Note: Numbers in parentheses refer to explanatory notes in Clause 5.3.5.







No	Symbol (1) (2)	Description
1		<ul style="list-style-type: none"> Measuring, input, or readout device. [*] = Instrument tag number. Symbols from Table 5.2.1 may be used.
2	(3) (4) 	<ul style="list-style-type: none"> Automatic single-mode controller.
3	(3) (4) 	<ul style="list-style-type: none"> Automatic two-mode controller.
4	(3) (4) 	<ul style="list-style-type: none"> Automatic three-mode controller.
5	(3) (4) 	<ul style="list-style-type: none"> Automatic signal processor.
6	(4) 	<ul style="list-style-type: none"> Manual signal processor.
7	(3) (4) 	<ul style="list-style-type: none"> Final control element. Control valve.
8	(3) (4) 	<ul style="list-style-type: none"> Final control element with positioner. Control valve with positioner.

Table 5.6 — Signal processing function block symbols

Note: Numbers in parentheses refer to explanatory notes in Clause 5.3.6.

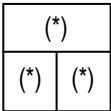



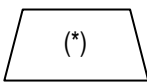
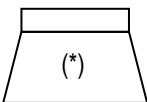

No	Function	Equation	Definition
	Symbol (1) (2)	Graph	
1	Summation	$M = X_1 + X_2 \dots + X_n$	<ul style="list-style-type: none"> Output equals algebraic sum of inputs.
	<div style="text-align: center;">  </div> <div style="text-align: center;">  </div>		
2	Average	$M = X_1 + X_2 \dots + X_n/n$	<ul style="list-style-type: none"> Output equals algebraic sum of inputs divided by number of inputs.
	<div style="text-align: center;">  </div> <div style="text-align: center;">  </div>		
3	Difference	$M = X_1 - X_2$	<ul style="list-style-type: none"> Output equals algebraic difference of two inputs.
	<div style="text-align: center;">  </div> <div style="text-align: center;">  </div>		
4	Multiplication	$M = X_1 \times X_2$	<ul style="list-style-type: none"> Output equals product of two inputs.
	<div style="text-align: center;">  </div> <div style="text-align: center;">  </div>		

Table 5.6 — Signal processing function block symbols

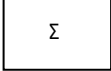
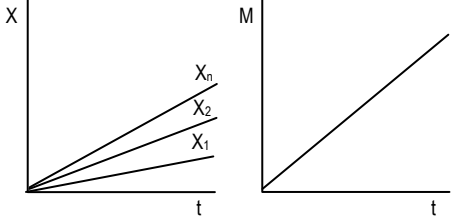
Note: Numbers in parentheses refer to explanatory notes in Clause 5.3.6.

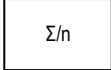
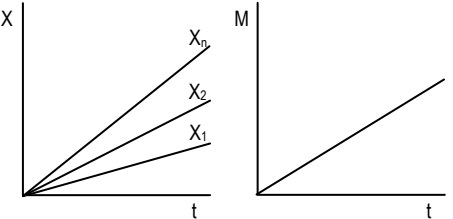

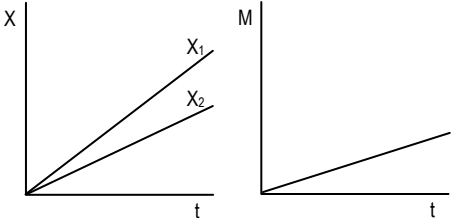

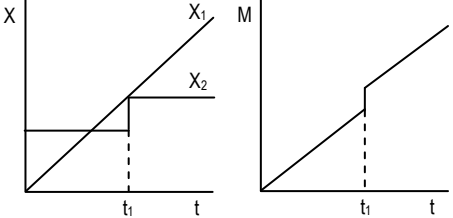

No	Function	Equation	Definition
	Symbol (1) (2)	Graph	
5	Division	$M = X_1 \div X_2$	<ul style="list-style-type: none"> Output equals quotient of two inputs.
	<div style="text-align: center;">  </div> <div style="text-align: center;">  </div>		
6	Exponential	$M = X^n$	<ul style="list-style-type: none"> Output equals nth power of input.
	<div style="text-align: center;">  </div> <div style="text-align: center;">  </div>		
7	Root extraction	$M = \sqrt[n]{X}$	<ul style="list-style-type: none"> Output equals nth root of input. If 'n' omitted, square root is assumed.
	<div style="text-align: center;">  </div> <div style="text-align: center;">  </div>		
8	Proportion	$M = KX$ or $M = PX$	<ul style="list-style-type: none"> Output proportional to input. Replace 'K' or 'P' with '1:1' for volume boosters. Replace 'K' or 'P' with '2:1', '3:1', etc., for integer gains.
	<div style="text-align: center;"> <p>(3)</p> <p>a)  b) </p> </div> <div style="text-align: center;"> <p>(3)</p> <p>a) </p> <p>b) </p> </div>		

Table 5.6 — Signal processing function block symbols

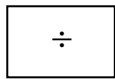
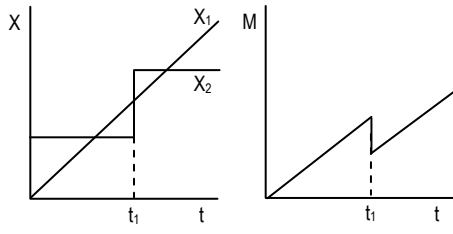
Note: Numbers in parentheses refer to explanatory notes in Clause 5.3.6.

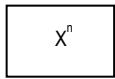
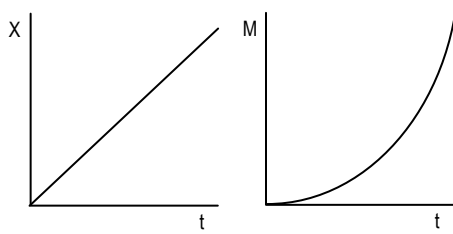

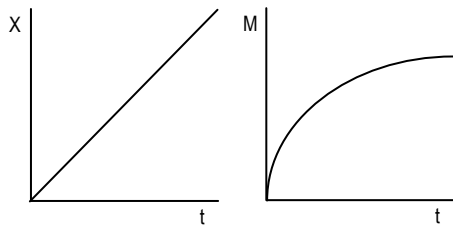

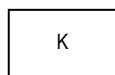
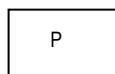
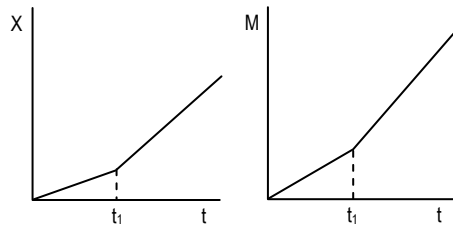







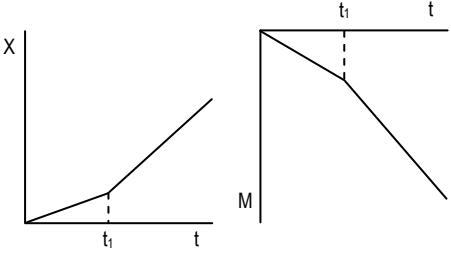

No	Function	Equation	Definition
	Symbol (1) (2)	Graph	
9	Reverse proportion	$M = -KX$ or $M = -PX$	<ul style="list-style-type: none"> Output inversely proportional to input. Replace '-K' or '-P' with '-1:1' for volume boosters. Replace '-K' or '-P' with '-2:1', '-3:1', etc., for integer gains.
	(3) a)  b)  (3) a)  b) 		
10	Integral	$M = (1/T_I)IXdt$	<ul style="list-style-type: none"> Output varies with magnitude and time duration of input. Output proportional to time integral of input. T_I = Integral time constant.
	(3) a)  b)  (3) a)  b) 		
11	Derivative	$M = T_D (dx/dt)$	<ul style="list-style-type: none"> Output proportional to time rate of change of input. T_D = derivative time constant.
	(3) a)  b)  (3) a)  b) 		
12	Unspecified function	$M = f(x)$	<ul style="list-style-type: none"> Output is a nonlinear or unspecified function of the input. Function defined in note or other text.
	 		

Table 5.6 — Signal processing function block symbols

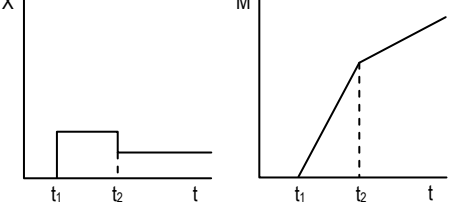
Note: Numbers in parentheses refer to explanatory notes in Clause 5.3.6.

No	Function	Equation	Definition
	Symbol (1) (2)	Graph	
13	Time function	$M = Xf(t)$	<ul style="list-style-type: none"> • Output equals a nonlinear or unspecified time function times the input. • Output is a nonlinear or unspecified time function. • Function defined in note or other text.
	<div style="border: 1px solid black; width: 40px; height: 20px; margin: 0 auto; text-align: center; line-height: 20px;">f(t)</div> <div style="border: 1px solid black; width: 60px; height: 30px; margin: 10px auto; text-align: center; line-height: 30px;">f(t)</div>		
14	Conversion	$I = P, P = I, \text{ etc}$	<ul style="list-style-type: none"> • Output signal type different from that of input signal. • Input signal is on the left and output signal is on the right. • Substitute any of the following signal types for 'P' or 'I': • A = Analog H = Hydraulic • B = Binary I = Current • D = Digital O = Electromagnetic • E = Voltage P = Pneumatic • F = Frequency R = Resistance
	<div style="border: 1px solid black; width: 40px; height: 20px; margin: 0 auto; text-align: center; line-height: 20px;">I/P</div> <div style="border: 1px solid black; width: 60px; height: 30px; margin: 10px auto; text-align: center; line-height: 30px;">I/P</div>		
15	High signal select	$M = X_1 \text{ for } X_1 > X_2$ $M = X_2 \text{ for } X_1 \leq X_2$	<ul style="list-style-type: none"> • Output equals greater of 2 or more inputs.
	<div style="border: 1px solid black; width: 40px; height: 20px; margin: 0 auto; text-align: center; line-height: 20px;">></div> <div style="border: 1px solid black; width: 60px; height: 30px; margin: 10px auto; text-align: center; line-height: 30px;">></div>		
16	Middle signal select	$M = X_1 \text{ for } X_2 > X_1 > X_3 \text{ or } X_3 > X_1 > X_2$ $M = X_2 \text{ for } X_1 > X_2 > X_3 \text{ or } X_3 > X_2 > X_1$ $M = X_3 \text{ for } X_1 > X_3 > X_2 \text{ or } X_2 > X_3 > X_1$	Output equals middle value of three or more inputs.
	<div style="border: 1px solid black; width: 40px; height: 20px; margin: 0 auto; text-align: center; line-height: 20px;">M</div> <div style="border: 1px solid black; width: 60px; height: 30px; margin: 10px auto; text-align: center; line-height: 30px;">M</div>		

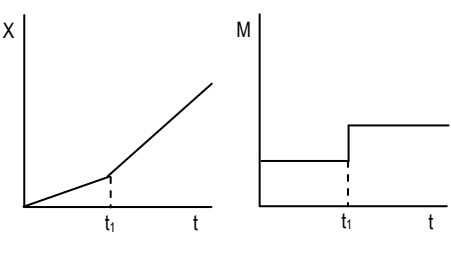
Table 5.6 — Signal processing function block symbols

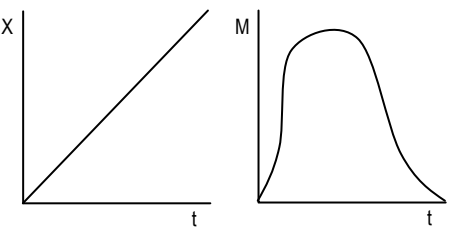
Note: Numbers in parentheses refer to explanatory notes in Clause 5.3.6.







No	Function	Equation	Definition
	Symbol (1) (2)	Graph	
17	Low signal select	$M = X_1$ for $X_1 \leq X_2$ $M = X_2$ for $X_1 \geq X_2$	<ul style="list-style-type: none"> Output equals lesser of 2 or more inputs.
	 		
18	High limit	$M = X$ for $X \leq H$ $M = H$ for $X \geq H$	<ul style="list-style-type: none"> Output equals the lower of the input or high limit values.
	 		
19	Low limit	$M = X$ for $X \geq L$ $M = L$ for $X \leq L$	<ul style="list-style-type: none"> Output equals the higher of the input or low limit values.
	 		
20	Positive bias	$M = X_1 + b$ $M = [-]X_2 + b$	<ul style="list-style-type: none"> Output equal to input plus an arbitrary value.
	 		

Table 5.6 — Signal processing function block symbols

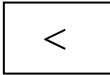
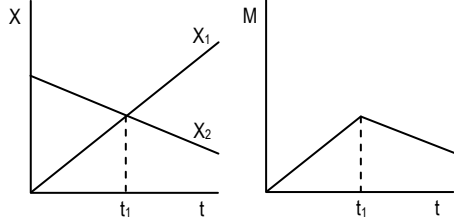
Note: Numbers in parentheses refer to explanatory notes in Clause 5.3.6.

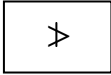
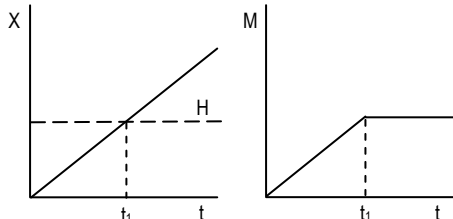

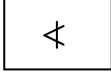
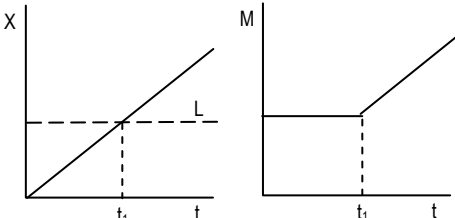

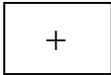
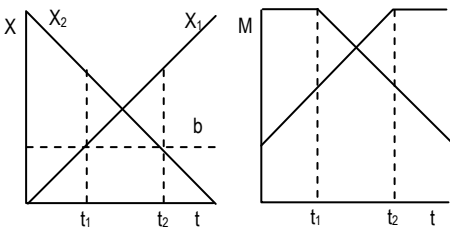



No	Function	Equation	Definition
	Symbol (1) (2)	Graph	
21	Negative Bias	$M = X_1 - b$ $M = [-]X_2 - b$	<ul style="list-style-type: none"> Output equal to input minus an arbitrary value.
	 		
22	Velocity limiter	$dM/dt = dX/dt$ for $dX/dt \leq H$, $M = X$ $dM/dt = H$ for $dX/dt \geq H$, $M \neq X$	<ul style="list-style-type: none"> Output equals input as long as the input rate of change does not exceed the limit value that establishes the output rate of change until the output again equals the input.
	(3) a)  b)  (3) a)  b) 		
23	High signal monitor	(State 1) $M = 0 @ X < H$ (State 2) $M = 1 @ X \geq H$	<ul style="list-style-type: none"> Output state is dependent on value of input. Output changes state when input is equal to or higher than an arbitrary high limit.
	 		
24	Low signal monitor	(State 1) $M = 1 @ X \leq L$ (State 2) $M = 0 @ X > L$	<ul style="list-style-type: none"> Output state is dependent on value of input. Output changes state when input is equal to or lower than an arbitrary low limit.
	 		

Table 5.6 — Signal processing function block symbols

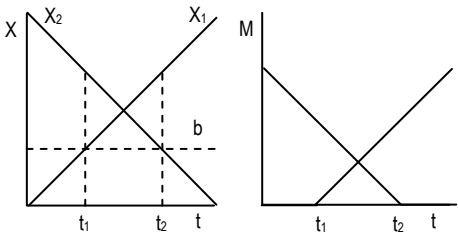
Note: Numbers in parentheses refer to explanatory notes in Clause 5.3.6.

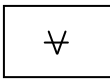
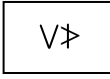
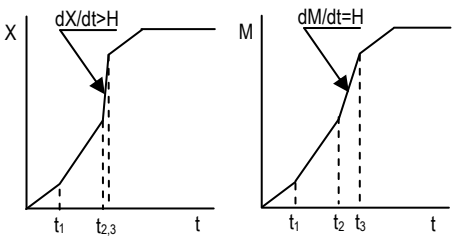

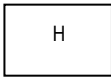
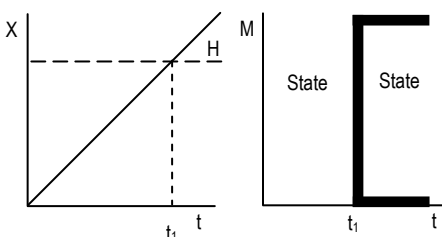

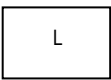
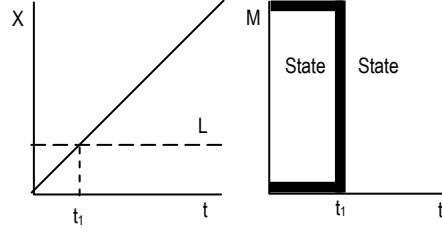

No	Function	Equation	Definition
	Symbol (1) (2)	Graph	
25	High/low signal monitor	(State 1) $M = 1 @ X \leq L$ (State 2) $M = 0 @ L < X < H$ (State 3) $M = 1 @ X \geq H$	<ul style="list-style-type: none"> Output states are dependent on value of input. Output changes state when input is equal to or lower than an arbitrary low limit or equal to or higher than an arbitrary high limit.
	 		
26	Analog signal generator	No equation	<ul style="list-style-type: none"> Output equals a variable analog signal that is generated: <ul style="list-style-type: none"> a. Automatically and is not adjustable by operator. b. Manually and is adjustable by operator.
	 	No graph	
27	Binary signal generator	No equation	<ul style="list-style-type: none"> Output equals an on-off binary signal that is generated: <ul style="list-style-type: none"> a. Automatically and is not adjustable by operator. b. Manually and is adjustable by operator.
	 	No graph	
28	Signal transfer	(State 1) $M = X_1$ (State 2) $M = X_2$	<ul style="list-style-type: none"> Output equals input that is selected by transfer. Transfer actuated by external signal.
	 		

Table 5.7 — Binary logic symbols

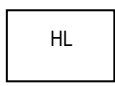
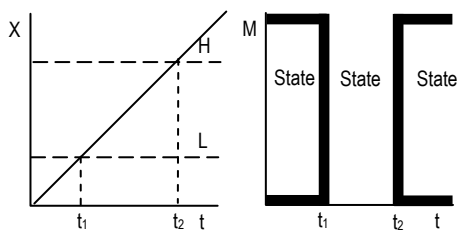
Note: Numbers in parentheses refer to explanatory notes in Clause 5.3.7.

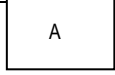
No	Function	Definition (1)																																																																																																						
	Symbol																																																																																																							
	Truth Table (1)	Graph																																																																																																						
1	AND gate	<ul style="list-style-type: none"> Output true only if all inputs are true. Alternate symbol. (2) (3) 																																																																																																						
																																																																																																								
	<table border="1" data-bbox="284 735 511 1155"> <thead> <tr> <th></th> <th>A</th> <th>B</th> <th>C</th> <th>X</th> <th>O</th> </tr> </thead> <tbody> <tr><td>1</td><td>0</td><td>0</td><td>0</td><td>0</td><td>0</td></tr> <tr><td>2</td><td>1</td><td>0</td><td>0</td><td>0</td><td>0</td></tr> <tr><td>3</td><td>0</td><td>1</td><td>0</td><td>0</td><td>0</td></tr> <tr><td>4</td><td>0</td><td>0</td><td>1</td><td>0</td><td>0</td></tr> <tr><td>5</td><td>0</td><td>0</td><td>0</td><td>1</td><td>0</td></tr> <tr><td>6</td><td>1</td><td>1</td><td>0</td><td>0</td><td>0</td></tr> <tr><td>7</td><td>1</td><td>0</td><td>1</td><td>0</td><td>0</td></tr> <tr><td>8</td><td>1</td><td>0</td><td>0</td><td>1</td><td>0</td></tr> <tr><td>9</td><td>0</td><td>1</td><td>1</td><td>0</td><td>0</td></tr> <tr><td>10</td><td>0</td><td>1</td><td>0</td><td>1</td><td>0</td></tr> <tr><td>11</td><td>0</td><td>0</td><td>1</td><td>1</td><td>0</td></tr> <tr><td>12</td><td>1</td><td>1</td><td>1</td><td>0</td><td>0</td></tr> <tr><td>13</td><td>1</td><td>1</td><td>0</td><td>1</td><td>0</td></tr> <tr><td>14</td><td>1</td><td>0</td><td>1</td><td>1</td><td>0</td></tr> <tr><td>15</td><td>0</td><td>1</td><td>1</td><td>1</td><td>0</td></tr> <tr><td>16</td><td>1</td><td>1</td><td>1</td><td>1</td><td>1</td></tr> </tbody> </table>		A	B	C	X	O	1	0	0	0	0	0	2	1	0	0	0	0	3	0	1	0	0	0	4	0	0	1	0	0	5	0	0	0	1	0	6	1	1	0	0	0	7	1	0	1	0	0	8	1	0	0	1	0	9	0	1	1	0	0	10	0	1	0	1	0	11	0	0	1	1	0	12	1	1	1	0	0	13	1	1	0	1	0	14	1	0	1	1	0	15	0	1	1	1	0	16	1	1	1	1	1	
	A	B	C	X	O																																																																																																			
1	0	0	0	0	0																																																																																																			
2	1	0	0	0	0																																																																																																			
3	0	1	0	0	0																																																																																																			
4	0	0	1	0	0																																																																																																			
5	0	0	0	1	0																																																																																																			
6	1	1	0	0	0																																																																																																			
7	1	0	1	0	0																																																																																																			
8	1	0	0	1	0																																																																																																			
9	0	1	1	0	0																																																																																																			
10	0	1	0	1	0																																																																																																			
11	0	0	1	1	0																																																																																																			
12	1	1	1	0	0																																																																																																			
13	1	1	0	1	0																																																																																																			
14	1	0	1	1	0																																																																																																			
15	0	1	1	1	0																																																																																																			
16	1	1	1	1	1																																																																																																			
2	OR gate	<ul style="list-style-type: none"> Output true if any input is true. Alternate symbol. (2) (3) 																																																																																																						
																																																																																																								
	<table border="1" data-bbox="284 1449 511 1869"> <thead> <tr> <th></th> <th>A</th> <th>B</th> <th>C</th> <th>X</th> <th>O</th> </tr> </thead> <tbody> <tr><td>1</td><td>0</td><td>0</td><td>0</td><td>0</td><td>0</td></tr> <tr><td>2</td><td>1</td><td>0</td><td>0</td><td>0</td><td>1</td></tr> <tr><td>3</td><td>0</td><td>1</td><td>0</td><td>0</td><td>1</td></tr> <tr><td>4</td><td>0</td><td>0</td><td>1</td><td>0</td><td>1</td></tr> <tr><td>5</td><td>0</td><td>0</td><td>0</td><td>1</td><td>1</td></tr> <tr><td>6</td><td>1</td><td>1</td><td>0</td><td>0</td><td>1</td></tr> <tr><td>7</td><td>1</td><td>0</td><td>1</td><td>0</td><td>1</td></tr> <tr><td>8</td><td>1</td><td>0</td><td>0</td><td>1</td><td>1</td></tr> <tr><td>9</td><td>0</td><td>1</td><td>1</td><td>0</td><td>1</td></tr> <tr><td>10</td><td>0</td><td>1</td><td>0</td><td>1</td><td>1</td></tr> <tr><td>11</td><td>0</td><td>0</td><td>1</td><td>1</td><td>1</td></tr> <tr><td>12</td><td>1</td><td>1</td><td>1</td><td>0</td><td>1</td></tr> <tr><td>13</td><td>1</td><td>1</td><td>0</td><td>1</td><td>1</td></tr> <tr><td>14</td><td>1</td><td>0</td><td>1</td><td>1</td><td>1</td></tr> <tr><td>15</td><td>0</td><td>1</td><td>1</td><td>1</td><td>1</td></tr> <tr><td>16</td><td>1</td><td>1</td><td>1</td><td>1</td><td>1</td></tr> </tbody> </table>		A	B	C	X	O	1	0	0	0	0	0	2	1	0	0	0	1	3	0	1	0	0	1	4	0	0	1	0	1	5	0	0	0	1	1	6	1	1	0	0	1	7	1	0	1	0	1	8	1	0	0	1	1	9	0	1	1	0	1	10	0	1	0	1	1	11	0	0	1	1	1	12	1	1	1	0	1	13	1	1	0	1	1	14	1	0	1	1	1	15	0	1	1	1	1	16	1	1	1	1	1	
	A	B	C	X	O																																																																																																			
1	0	0	0	0	0																																																																																																			
2	1	0	0	0	1																																																																																																			
3	0	1	0	0	1																																																																																																			
4	0	0	1	0	1																																																																																																			
5	0	0	0	1	1																																																																																																			
6	1	1	0	0	1																																																																																																			
7	1	0	1	0	1																																																																																																			
8	1	0	0	1	1																																																																																																			
9	0	1	1	0	1																																																																																																			
10	0	1	0	1	1																																																																																																			
11	0	0	1	1	1																																																																																																			
12	1	1	1	0	1																																																																																																			
13	1	1	0	1	1																																																																																																			
14	1	0	1	1	1																																																																																																			
15	0	1	1	1	1																																																																																																			
16	1	1	1	1	1																																																																																																			

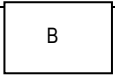
Table 5.7 — Binary logic symbols

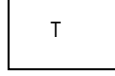
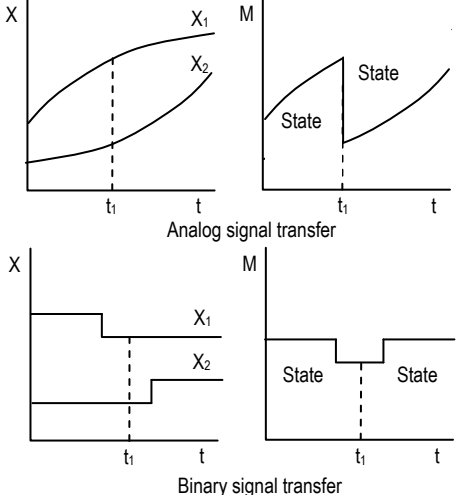
Note: Numbers in parentheses refer to explanatory notes in Clause 5.3.7.

No	Function	Definition (1)																																																																																																					
	Symbol																																																																																																						
	Truth Table (1)	Graph																																																																																																					
3	NAND gate	<ul style="list-style-type: none"> Output true only if all inputs are false. Output false if any input is true. 																																																																																																					
																																																																																																							
	<table border="1"> <thead> <tr> <th></th> <th>A</th> <th>B</th> <th>C</th> <th>X</th> <th>O</th> </tr> </thead> <tbody> <tr><td>1</td><td>0</td><td>0</td><td>0</td><td>0</td><td>1</td></tr> <tr><td>2</td><td>1</td><td>0</td><td>0</td><td>0</td><td>0</td></tr> <tr><td>3</td><td>0</td><td>1</td><td>0</td><td>0</td><td>0</td></tr> <tr><td>4</td><td>0</td><td>0</td><td>1</td><td>0</td><td>0</td></tr> <tr><td>5</td><td>0</td><td>0</td><td>0</td><td>1</td><td>0</td></tr> <tr><td>6</td><td>1</td><td>1</td><td>0</td><td>0</td><td>0</td></tr> <tr><td>7</td><td>1</td><td>0</td><td>1</td><td>0</td><td>0</td></tr> <tr><td>8</td><td>1</td><td>0</td><td>0</td><td>1</td><td>0</td></tr> <tr><td>9</td><td>0</td><td>1</td><td>1</td><td>0</td><td>0</td></tr> <tr><td>10</td><td>0</td><td>1</td><td>0</td><td>1</td><td>0</td></tr> <tr><td>11</td><td>0</td><td>0</td><td>1</td><td>1</td><td>0</td></tr> <tr><td>12</td><td>1</td><td>1</td><td>1</td><td>0</td><td>0</td></tr> <tr><td>13</td><td>1</td><td>1</td><td>0</td><td>1</td><td>0</td></tr> <tr><td>14</td><td>1</td><td>0</td><td>1</td><td>1</td><td>0</td></tr> <tr><td>15</td><td>0</td><td>1</td><td>1</td><td>1</td><td>0</td></tr> <tr><td>16</td><td>1</td><td>1</td><td>1</td><td>1</td><td>0</td></tr> </tbody> </table>		A	B	C	X	O	1	0	0	0	0	1	2	1	0	0	0	0	3	0	1	0	0	0	4	0	0	1	0	0	5	0	0	0	1	0	6	1	1	0	0	0	7	1	0	1	0	0	8	1	0	0	1	0	9	0	1	1	0	0	10	0	1	0	1	0	11	0	0	1	1	0	12	1	1	1	0	0	13	1	1	0	1	0	14	1	0	1	1	0	15	0	1	1	1	0	16	1	1	1	1	0
	A	B	C	X	O																																																																																																		
1	0	0	0	0	1																																																																																																		
2	1	0	0	0	0																																																																																																		
3	0	1	0	0	0																																																																																																		
4	0	0	1	0	0																																																																																																		
5	0	0	0	1	0																																																																																																		
6	1	1	0	0	0																																																																																																		
7	1	0	1	0	0																																																																																																		
8	1	0	0	1	0																																																																																																		
9	0	1	1	0	0																																																																																																		
10	0	1	0	1	0																																																																																																		
11	0	0	1	1	0																																																																																																		
12	1	1	1	0	0																																																																																																		
13	1	1	0	1	0																																																																																																		
14	1	0	1	1	0																																																																																																		
15	0	1	1	1	0																																																																																																		
16	1	1	1	1	0																																																																																																		
4	NOR gate	<ul style="list-style-type: none"> Output true if any input is false. Output false if any input is true. 																																																																																																					
																																																																																																							
	<table border="1"> <thead> <tr> <th></th> <th>A</th> <th>B</th> <th>C</th> <th>X</th> <th>O</th> </tr> </thead> <tbody> <tr><td>1</td><td>0</td><td>0</td><td>0</td><td>0</td><td>1</td></tr> <tr><td>2</td><td>1</td><td>0</td><td>0</td><td>0</td><td>1</td></tr> <tr><td>3</td><td>0</td><td>1</td><td>0</td><td>0</td><td>1</td></tr> <tr><td>4</td><td>0</td><td>0</td><td>1</td><td>0</td><td>1</td></tr> <tr><td>5</td><td>0</td><td>0</td><td>0</td><td>1</td><td>1</td></tr> <tr><td>6</td><td>1</td><td>1</td><td>0</td><td>0</td><td>1</td></tr> <tr><td>7</td><td>1</td><td>0</td><td>1</td><td>0</td><td>1</td></tr> <tr><td>8</td><td>1</td><td>0</td><td>0</td><td>1</td><td>1</td></tr> <tr><td>9</td><td>0</td><td>1</td><td>1</td><td>0</td><td>1</td></tr> <tr><td>10</td><td>0</td><td>1</td><td>0</td><td>1</td><td>1</td></tr> <tr><td>11</td><td>0</td><td>0</td><td>1</td><td>1</td><td>1</td></tr> <tr><td>12</td><td>1</td><td>1</td><td>1</td><td>0</td><td>1</td></tr> <tr><td>13</td><td>1</td><td>1</td><td>0</td><td>1</td><td>1</td></tr> <tr><td>14</td><td>1</td><td>0</td><td>1</td><td>1</td><td>1</td></tr> <tr><td>15</td><td>0</td><td>1</td><td>1</td><td>1</td><td>1</td></tr> <tr><td>16</td><td>1</td><td>1</td><td>1</td><td>1</td><td>0</td></tr> </tbody> </table>		A	B	C	X	O	1	0	0	0	0	1	2	1	0	0	0	1	3	0	1	0	0	1	4	0	0	1	0	1	5	0	0	0	1	1	6	1	1	0	0	1	7	1	0	1	0	1	8	1	0	0	1	1	9	0	1	1	0	1	10	0	1	0	1	1	11	0	0	1	1	1	12	1	1	1	0	1	13	1	1	0	1	1	14	1	0	1	1	1	15	0	1	1	1	1	16	1	1	1	1	0
	A	B	C	X	O																																																																																																		
1	0	0	0	0	1																																																																																																		
2	1	0	0	0	1																																																																																																		
3	0	1	0	0	1																																																																																																		
4	0	0	1	0	1																																																																																																		
5	0	0	0	1	1																																																																																																		
6	1	1	0	0	1																																																																																																		
7	1	0	1	0	1																																																																																																		
8	1	0	0	1	1																																																																																																		
9	0	1	1	0	1																																																																																																		
10	0	1	0	1	1																																																																																																		
11	0	0	1	1	1																																																																																																		
12	1	1	1	0	1																																																																																																		
13	1	1	0	1	1																																																																																																		
14	1	0	1	1	1																																																																																																		
15	0	1	1	1	1																																																																																																		
16	1	1	1	1	0																																																																																																		

Table 5.7 — Binary logic symbols

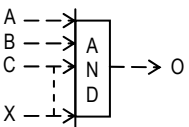
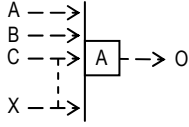
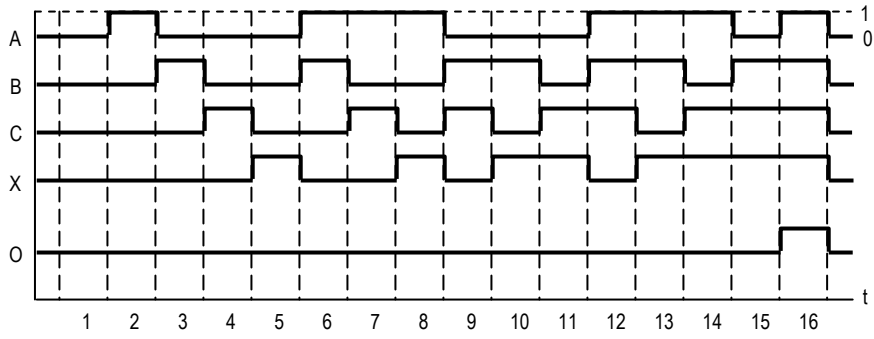
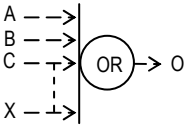
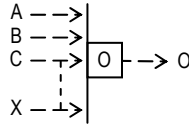
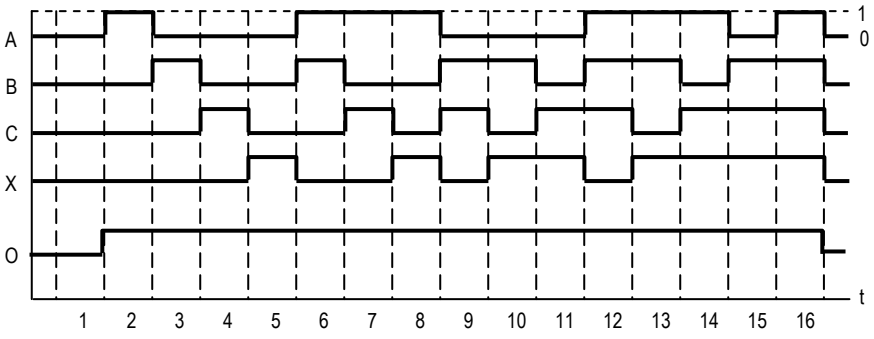
Note: Numbers in parentheses refer to explanatory notes in Clause 5.3.7.

No	Function	Definition (1)																																																																																																					
	Symbol																																																																																																						
	Truth Table (1)		Graph																																																																																																				
5	Qualified OR gate Greater or equal to 'n'	<ul style="list-style-type: none"> Output true if number of true inputs is greater than or equal to 'n'. Truth table and graph are for n = 2. 																																																																																																					
	<table border="1"> <thead> <tr> <th></th> <th>A</th> <th>B</th> <th>C</th> <th>X</th> <th>O</th> </tr> </thead> <tbody> <tr><td>1</td><td>0</td><td>0</td><td>0</td><td>0</td><td>0</td></tr> <tr><td>2</td><td>1</td><td>0</td><td>0</td><td>0</td><td>0</td></tr> <tr><td>3</td><td>0</td><td>1</td><td>0</td><td>0</td><td>0</td></tr> <tr><td>4</td><td>0</td><td>0</td><td>1</td><td>0</td><td>0</td></tr> <tr><td>5</td><td>0</td><td>0</td><td>0</td><td>1</td><td>0</td></tr> <tr><td>6</td><td>1</td><td>1</td><td>0</td><td>0</td><td>1</td></tr> <tr><td>7</td><td>1</td><td>0</td><td>1</td><td>0</td><td>1</td></tr> <tr><td>8</td><td>1</td><td>0</td><td>0</td><td>1</td><td>1</td></tr> <tr><td>9</td><td>0</td><td>1</td><td>1</td><td>0</td><td>1</td></tr> <tr><td>10</td><td>0</td><td>1</td><td>0</td><td>1</td><td>1</td></tr> <tr><td>11</td><td>0</td><td>0</td><td>1</td><td>1</td><td>1</td></tr> <tr><td>12</td><td>1</td><td>1</td><td>1</td><td>0</td><td>1</td></tr> <tr><td>13</td><td>1</td><td>1</td><td>0</td><td>1</td><td>1</td></tr> <tr><td>14</td><td>1</td><td>0</td><td>1</td><td>1</td><td>1</td></tr> <tr><td>15</td><td>0</td><td>1</td><td>1</td><td>1</td><td>1</td></tr> <tr><td>16</td><td>1</td><td>1</td><td>1</td><td>1</td><td>1</td></tr> </tbody> </table>			A	B	C	X	O	1	0	0	0	0	0	2	1	0	0	0	0	3	0	1	0	0	0	4	0	0	1	0	0	5	0	0	0	1	0	6	1	1	0	0	1	7	1	0	1	0	1	8	1	0	0	1	1	9	0	1	1	0	1	10	0	1	0	1	1	11	0	0	1	1	1	12	1	1	1	0	1	13	1	1	0	1	1	14	1	0	1	1	1	15	0	1	1	1	1	16	1	1	1	1
	A	B	C	X	O																																																																																																		
1	0	0	0	0	0																																																																																																		
2	1	0	0	0	0																																																																																																		
3	0	1	0	0	0																																																																																																		
4	0	0	1	0	0																																																																																																		
5	0	0	0	1	0																																																																																																		
6	1	1	0	0	1																																																																																																		
7	1	0	1	0	1																																																																																																		
8	1	0	0	1	1																																																																																																		
9	0	1	1	0	1																																																																																																		
10	0	1	0	1	1																																																																																																		
11	0	0	1	1	1																																																																																																		
12	1	1	1	0	1																																																																																																		
13	1	1	0	1	1																																																																																																		
14	1	0	1	1	1																																																																																																		
15	0	1	1	1	1																																																																																																		
16	1	1	1	1	1																																																																																																		
6	Qualified OR gate Greater than 'n'	<ul style="list-style-type: none"> Output true if number of true inputs is greater than 'n'. Truth table and graph are for n = 2. 																																																																																																					
	<table border="1"> <thead> <tr> <th></th> <th>A</th> <th>B</th> <th>C</th> <th>X</th> <th>O</th> </tr> </thead> <tbody> <tr><td>1</td><td>0</td><td>0</td><td>0</td><td>0</td><td>0</td></tr> <tr><td>2</td><td>1</td><td>0</td><td>0</td><td>0</td><td>0</td></tr> <tr><td>3</td><td>0</td><td>1</td><td>0</td><td>0</td><td>0</td></tr> <tr><td>4</td><td>0</td><td>0</td><td>1</td><td>0</td><td>0</td></tr> <tr><td>5</td><td>0</td><td>0</td><td>0</td><td>1</td><td>0</td></tr> <tr><td>6</td><td>1</td><td>1</td><td>0</td><td>0</td><td>0</td></tr> <tr><td>7</td><td>1</td><td>0</td><td>1</td><td>0</td><td>0</td></tr> <tr><td>8</td><td>1</td><td>0</td><td>0</td><td>1</td><td>0</td></tr> <tr><td>9</td><td>0</td><td>1</td><td>1</td><td>0</td><td>0</td></tr> <tr><td>10</td><td>0</td><td>1</td><td>0</td><td>1</td><td>0</td></tr> <tr><td>11</td><td>0</td><td>0</td><td>1</td><td>1</td><td>0</td></tr> <tr><td>12</td><td>1</td><td>1</td><td>1</td><td>0</td><td>1</td></tr> <tr><td>13</td><td>1</td><td>1</td><td>0</td><td>1</td><td>1</td></tr> <tr><td>14</td><td>1</td><td>0</td><td>1</td><td>1</td><td>1</td></tr> <tr><td>15</td><td>0</td><td>1</td><td>1</td><td>1</td><td>1</td></tr> <tr><td>16</td><td>1</td><td>1</td><td>1</td><td>1</td><td>1</td></tr> </tbody> </table>			A	B	C	X	O	1	0	0	0	0	0	2	1	0	0	0	0	3	0	1	0	0	0	4	0	0	1	0	0	5	0	0	0	1	0	6	1	1	0	0	0	7	1	0	1	0	0	8	1	0	0	1	0	9	0	1	1	0	0	10	0	1	0	1	0	11	0	0	1	1	0	12	1	1	1	0	1	13	1	1	0	1	1	14	1	0	1	1	1	15	0	1	1	1	1	16	1	1	1	1
	A	B	C	X	O																																																																																																		
1	0	0	0	0	0																																																																																																		
2	1	0	0	0	0																																																																																																		
3	0	1	0	0	0																																																																																																		
4	0	0	1	0	0																																																																																																		
5	0	0	0	1	0																																																																																																		
6	1	1	0	0	0																																																																																																		
7	1	0	1	0	0																																																																																																		
8	1	0	0	1	0																																																																																																		
9	0	1	1	0	0																																																																																																		
10	0	1	0	1	0																																																																																																		
11	0	0	1	1	0																																																																																																		
12	1	1	1	0	1																																																																																																		
13	1	1	0	1	1																																																																																																		
14	1	0	1	1	1																																																																																																		
15	0	1	1	1	1																																																																																																		
16	1	1	1	1	1																																																																																																		

Table 5.7 — Binary logic symbols

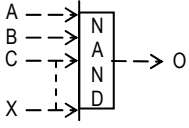
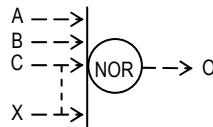
Note: Numbers in parentheses refer to explanatory notes in Clause 5.3.7.

No	Function	Definition (1)																																																																																																					
	Symbol																																																																																																						
	Truth Table (1)		Graph																																																																																																				
7	Qualified OR gate Less or equal to 'n'	<ul style="list-style-type: none"> Output true if number of true inputs is less than or equal to 'n'. Truth table and graph are for n = 2. 																																																																																																					
	<table border="1"> <thead> <tr> <th></th> <th>A</th> <th>B</th> <th>C</th> <th>X</th> <th>O</th> </tr> </thead> <tbody> <tr><td>1</td><td>0</td><td>0</td><td>0</td><td>0</td><td>1</td></tr> <tr><td>2</td><td>1</td><td>0</td><td>0</td><td>0</td><td>1</td></tr> <tr><td>3</td><td>0</td><td>1</td><td>0</td><td>0</td><td>1</td></tr> <tr><td>4</td><td>0</td><td>0</td><td>1</td><td>0</td><td>1</td></tr> <tr><td>5</td><td>0</td><td>0</td><td>0</td><td>1</td><td>1</td></tr> <tr><td>6</td><td>1</td><td>1</td><td>0</td><td>0</td><td>1</td></tr> <tr><td>7</td><td>1</td><td>0</td><td>1</td><td>0</td><td>1</td></tr> <tr><td>8</td><td>1</td><td>0</td><td>0</td><td>1</td><td>1</td></tr> <tr><td>9</td><td>0</td><td>1</td><td>1</td><td>0</td><td>1</td></tr> <tr><td>10</td><td>0</td><td>1</td><td>0</td><td>1</td><td>1</td></tr> <tr><td>11</td><td>0</td><td>0</td><td>1</td><td>1</td><td>1</td></tr> <tr><td>12</td><td>1</td><td>1</td><td>1</td><td>0</td><td>0</td></tr> <tr><td>13</td><td>1</td><td>1</td><td>0</td><td>1</td><td>0</td></tr> <tr><td>14</td><td>1</td><td>0</td><td>1</td><td>1</td><td>0</td></tr> <tr><td>15</td><td>0</td><td>1</td><td>1</td><td>1</td><td>0</td></tr> <tr><td>16</td><td>1</td><td>1</td><td>1</td><td>1</td><td>0</td></tr> </tbody> </table>			A	B	C	X	O	1	0	0	0	0	1	2	1	0	0	0	1	3	0	1	0	0	1	4	0	0	1	0	1	5	0	0	0	1	1	6	1	1	0	0	1	7	1	0	1	0	1	8	1	0	0	1	1	9	0	1	1	0	1	10	0	1	0	1	1	11	0	0	1	1	1	12	1	1	1	0	0	13	1	1	0	1	0	14	1	0	1	1	0	15	0	1	1	1	0	16	1	1	1	1
	A	B	C	X	O																																																																																																		
1	0	0	0	0	1																																																																																																		
2	1	0	0	0	1																																																																																																		
3	0	1	0	0	1																																																																																																		
4	0	0	1	0	1																																																																																																		
5	0	0	0	1	1																																																																																																		
6	1	1	0	0	1																																																																																																		
7	1	0	1	0	1																																																																																																		
8	1	0	0	1	1																																																																																																		
9	0	1	1	0	1																																																																																																		
10	0	1	0	1	1																																																																																																		
11	0	0	1	1	1																																																																																																		
12	1	1	1	0	0																																																																																																		
13	1	1	0	1	0																																																																																																		
14	1	0	1	1	0																																																																																																		
15	0	1	1	1	0																																																																																																		
16	1	1	1	1	0																																																																																																		
8	Qualified OR gate Less than 'n'	<ul style="list-style-type: none"> Output true if number of true inputs is less than 'n'. Truth table and graph are for n = 2. 																																																																																																					
	<table border="1"> <thead> <tr> <th></th> <th>A</th> <th>B</th> <th>C</th> <th>X</th> <th>O</th> </tr> </thead> <tbody> <tr><td>1</td><td>0</td><td>0</td><td>0</td><td>0</td><td>1</td></tr> <tr><td>2</td><td>1</td><td>0</td><td>0</td><td>0</td><td>1</td></tr> <tr><td>3</td><td>0</td><td>1</td><td>0</td><td>0</td><td>1</td></tr> <tr><td>4</td><td>0</td><td>0</td><td>1</td><td>0</td><td>1</td></tr> <tr><td>5</td><td>0</td><td>0</td><td>0</td><td>1</td><td>1</td></tr> <tr><td>6</td><td>1</td><td>1</td><td>0</td><td>0</td><td>0</td></tr> <tr><td>7</td><td>1</td><td>0</td><td>1</td><td>0</td><td>0</td></tr> <tr><td>8</td><td>1</td><td>0</td><td>0</td><td>1</td><td>0</td></tr> <tr><td>9</td><td>0</td><td>1</td><td>1</td><td>0</td><td>0</td></tr> <tr><td>10</td><td>0</td><td>1</td><td>0</td><td>1</td><td>0</td></tr> <tr><td>11</td><td>0</td><td>0</td><td>1</td><td>1</td><td>0</td></tr> <tr><td>12</td><td>1</td><td>1</td><td>1</td><td>0</td><td>0</td></tr> <tr><td>13</td><td>1</td><td>1</td><td>0</td><td>1</td><td>0</td></tr> <tr><td>14</td><td>1</td><td>0</td><td>1</td><td>1</td><td>0</td></tr> <tr><td>15</td><td>0</td><td>1</td><td>1</td><td>1</td><td>0</td></tr> <tr><td>16</td><td>1</td><td>1</td><td>1</td><td>1</td><td>0</td></tr> </tbody> </table>			A	B	C	X	O	1	0	0	0	0	1	2	1	0	0	0	1	3	0	1	0	0	1	4	0	0	1	0	1	5	0	0	0	1	1	6	1	1	0	0	0	7	1	0	1	0	0	8	1	0	0	1	0	9	0	1	1	0	0	10	0	1	0	1	0	11	0	0	1	1	0	12	1	1	1	0	0	13	1	1	0	1	0	14	1	0	1	1	0	15	0	1	1	1	0	16	1	1	1	1
	A	B	C	X	O																																																																																																		
1	0	0	0	0	1																																																																																																		
2	1	0	0	0	1																																																																																																		
3	0	1	0	0	1																																																																																																		
4	0	0	1	0	1																																																																																																		
5	0	0	0	1	1																																																																																																		
6	1	1	0	0	0																																																																																																		
7	1	0	1	0	0																																																																																																		
8	1	0	0	1	0																																																																																																		
9	0	1	1	0	0																																																																																																		
10	0	1	0	1	0																																																																																																		
11	0	0	1	1	0																																																																																																		
12	1	1	1	0	0																																																																																																		
13	1	1	0	1	0																																																																																																		
14	1	0	1	1	0																																																																																																		
15	0	1	1	1	0																																																																																																		
16	1	1	1	1	0																																																																																																		

Table 5.7 — Binary logic symbols

Note: Numbers in parentheses refer to explanatory notes in Clause 5.3.7.

No	Function	Definition (1)																																																																																																					
	Symbol																																																																																																						
	Truth Table (1)																																																																																																						
		Graph																																																																																																					
9	Qualified OR gate Equal to 'n'	<ul style="list-style-type: none"> Output true if number of true inputs is equal to 'n'. Truth table and graph are for n = 2. 																																																																																																					
																																																																																																							
	<table border="1" data-bbox="292 724 516 1144"> <thead> <tr> <th></th> <th>A</th> <th>B</th> <th>C</th> <th>X</th> <th>O</th> </tr> </thead> <tbody> <tr><td>1</td><td>0</td><td>0</td><td>0</td><td>0</td><td>0</td></tr> <tr><td>2</td><td>1</td><td>0</td><td>0</td><td>0</td><td>0</td></tr> <tr><td>3</td><td>0</td><td>1</td><td>0</td><td>0</td><td>0</td></tr> <tr><td>4</td><td>0</td><td>0</td><td>1</td><td>0</td><td>0</td></tr> <tr><td>5</td><td>0</td><td>0</td><td>0</td><td>1</td><td>0</td></tr> <tr><td>6</td><td>1</td><td>1</td><td>0</td><td>0</td><td>1</td></tr> <tr><td>7</td><td>1</td><td>0</td><td>1</td><td>0</td><td>1</td></tr> <tr><td>8</td><td>1</td><td>0</td><td>0</td><td>1</td><td>1</td></tr> <tr><td>9</td><td>0</td><td>1</td><td>1</td><td>0</td><td>1</td></tr> <tr><td>10</td><td>0</td><td>1</td><td>0</td><td>1</td><td>1</td></tr> <tr><td>11</td><td>0</td><td>0</td><td>1</td><td>1</td><td>1</td></tr> <tr><td>12</td><td>1</td><td>1</td><td>1</td><td>0</td><td>0</td></tr> <tr><td>13</td><td>1</td><td>1</td><td>0</td><td>1</td><td>0</td></tr> <tr><td>14</td><td>1</td><td>0</td><td>1</td><td>1</td><td>0</td></tr> <tr><td>15</td><td>0</td><td>1</td><td>1</td><td>1</td><td>0</td></tr> <tr><td>16</td><td>1</td><td>1</td><td>1</td><td>1</td><td>0</td></tr> </tbody> </table>		A	B	C	X	O	1	0	0	0	0	0	2	1	0	0	0	0	3	0	1	0	0	0	4	0	0	1	0	0	5	0	0	0	1	0	6	1	1	0	0	1	7	1	0	1	0	1	8	1	0	0	1	1	9	0	1	1	0	1	10	0	1	0	1	1	11	0	0	1	1	1	12	1	1	1	0	0	13	1	1	0	1	0	14	1	0	1	1	0	15	0	1	1	1	0	16	1	1	1	1	0
	A	B	C	X	O																																																																																																		
1	0	0	0	0	0																																																																																																		
2	1	0	0	0	0																																																																																																		
3	0	1	0	0	0																																																																																																		
4	0	0	1	0	0																																																																																																		
5	0	0	0	1	0																																																																																																		
6	1	1	0	0	1																																																																																																		
7	1	0	1	0	1																																																																																																		
8	1	0	0	1	1																																																																																																		
9	0	1	1	0	1																																																																																																		
10	0	1	0	1	1																																																																																																		
11	0	0	1	1	1																																																																																																		
12	1	1	1	0	0																																																																																																		
13	1	1	0	1	0																																																																																																		
14	1	0	1	1	0																																																																																																		
15	0	1	1	1	0																																																																																																		
16	1	1	1	1	0																																																																																																		
10	Qualified OR gate Not equal to 'n'	<ul style="list-style-type: none"> Output true if number of true inputs is not equal to 'n'. Truth table and graph are for n = 2. 																																																																																																					
																																																																																																							
	<table border="1" data-bbox="292 1459 516 1879"> <thead> <tr> <th></th> <th>A</th> <th>B</th> <th>C</th> <th>X</th> <th>O</th> </tr> </thead> <tbody> <tr><td>1</td><td>0</td><td>0</td><td>0</td><td>0</td><td>1</td></tr> <tr><td>2</td><td>1</td><td>0</td><td>0</td><td>0</td><td>1</td></tr> <tr><td>3</td><td>0</td><td>1</td><td>0</td><td>0</td><td>1</td></tr> <tr><td>4</td><td>0</td><td>0</td><td>1</td><td>0</td><td>1</td></tr> <tr><td>5</td><td>0</td><td>0</td><td>0</td><td>1</td><td>1</td></tr> <tr><td>6</td><td>1</td><td>1</td><td>0</td><td>0</td><td>0</td></tr> <tr><td>7</td><td>1</td><td>0</td><td>1</td><td>0</td><td>0</td></tr> <tr><td>8</td><td>1</td><td>0</td><td>0</td><td>1</td><td>0</td></tr> <tr><td>9</td><td>0</td><td>1</td><td>1</td><td>0</td><td>0</td></tr> <tr><td>10</td><td>0</td><td>1</td><td>0</td><td>1</td><td>0</td></tr> <tr><td>11</td><td>0</td><td>0</td><td>1</td><td>1</td><td>0</td></tr> <tr><td>12</td><td>1</td><td>1</td><td>1</td><td>0</td><td>1</td></tr> <tr><td>13</td><td>1</td><td>1</td><td>0</td><td>1</td><td>1</td></tr> <tr><td>14</td><td>1</td><td>0</td><td>1</td><td>1</td><td>1</td></tr> <tr><td>15</td><td>0</td><td>1</td><td>1</td><td>1</td><td>1</td></tr> <tr><td>16</td><td>1</td><td>1</td><td>1</td><td>1</td><td>1</td></tr> </tbody> </table>		A	B	C	X	O	1	0	0	0	0	1	2	1	0	0	0	1	3	0	1	0	0	1	4	0	0	1	0	1	5	0	0	0	1	1	6	1	1	0	0	0	7	1	0	1	0	0	8	1	0	0	1	0	9	0	1	1	0	0	10	0	1	0	1	0	11	0	0	1	1	0	12	1	1	1	0	1	13	1	1	0	1	1	14	1	0	1	1	1	15	0	1	1	1	1	16	1	1	1	1	1
	A	B	C	X	O																																																																																																		
1	0	0	0	0	1																																																																																																		
2	1	0	0	0	1																																																																																																		
3	0	1	0	0	1																																																																																																		
4	0	0	1	0	1																																																																																																		
5	0	0	0	1	1																																																																																																		
6	1	1	0	0	0																																																																																																		
7	1	0	1	0	0																																																																																																		
8	1	0	0	1	0																																																																																																		
9	0	1	1	0	0																																																																																																		
10	0	1	0	1	0																																																																																																		
11	0	0	1	1	0																																																																																																		
12	1	1	1	0	1																																																																																																		
13	1	1	0	1	1																																																																																																		
14	1	0	1	1	1																																																																																																		
15	0	1	1	1	1																																																																																																		
16	1	1	1	1	1																																																																																																		

Table 5.7 — Binary logic symbols

Note: Numbers in parentheses refer to explanatory notes in Clause 5.3.7.

No	Function	Definition (1)																																												
	Symbol																																													
	Truth Table (1)																																													
		Graph																																												
11	NOT gate	<ul style="list-style-type: none"> Output false if input true. Output true if input false. 																																												
																																														
	<table border="1" style="display: inline-table; vertical-align: middle;"> <tr><td>A</td><td>O</td></tr> <tr><td>1</td><td>0</td></tr> <tr><td>0</td><td>1</td></tr> </table>		A	O	1	0	0	1																																						
A	O																																													
1	0																																													
0	1																																													
12	Basic memory	<ul style="list-style-type: none"> Outputs [C] and [D] are always opposite. If input [A] equals (1) then output [C] equals (1) and output [D] equals (0). If input [A] changes to (0) output [C] remains (1) until input [B] equals (1) then output [C] equals (1) and output [D] equals (0). If input [B] equals (1) then output [D] equals (1) and output [C] equals (0). If input [B] changes to (0) output [D] remains (1) until input [A] equals (1), then output [D] equals (1) and output [C] equals (0). If inputs [A] and [B] are simultaneously equal to (1) then outputs [C] and [D] change state. 																																												
																																														
	<table border="1" style="display: inline-table; vertical-align: middle;"> <tr><td></td><td>A</td><td>B</td><td>C</td><td>D</td></tr> <tr><td>1</td><td>0</td><td>0</td><td>0</td><td>1</td></tr> <tr><td>2</td><td>1</td><td>0</td><td>1</td><td>0</td></tr> <tr><td>3</td><td>0</td><td>0</td><td>1</td><td>0</td></tr> <tr><td>4</td><td>0</td><td>1</td><td>0</td><td>1</td></tr> <tr><td>5</td><td>0</td><td>0</td><td>0</td><td>1</td></tr> <tr><td>6</td><td>1</td><td>1</td><td>1</td><td>0</td></tr> <tr><td>7</td><td>0</td><td>0</td><td>1</td><td>0</td></tr> <tr><td>8</td><td>1</td><td>1</td><td>0</td><td>1</td></tr> </table>			A	B	C	D	1	0	0	0	1	2	1	0	1	0	3	0	0	1	0	4	0	1	0	1	5	0	0	0	1	6	1	1	1	0	7	0	0	1	0	8	1	1	0
	A	B	C	D																																										
1	0	0	0	1																																										
2	1	0	1	0																																										
3	0	0	1	0																																										
4	0	1	0	1																																										
5	0	0	0	1																																										
6	1	1	1	0																																										
7	0	0	1	0																																										
8	1	1	0	1																																										
13	Set dominant memory	<ul style="list-style-type: none"> Outputs [C] and [D] are always opposite. If input [A] equals (1) then output [C] equals (1) and output [D] equals (0). If input [A] changes to (0) output [C] remains (1) until input [B] equals (1) then output [C] equals (1) and output [D] equals (0). If input [B] equals (1) then output [D] equals (1) and output [C] equals (0). If input [B] changes to (0) output [D] remains (1) until input [A] equals (1), then output [D] equals (1) and output [C] equals (0). If inputs [A] and [B] are simultaneously equal to (1) then output [C] equals (1) and output [D] equals (0). 																																												
																																														
	<table border="1" style="display: inline-table; vertical-align: middle;"> <tr><td></td><td>A</td><td>B</td><td>C</td><td>D</td></tr> <tr><td>1</td><td>0</td><td>0</td><td>0</td><td>1</td></tr> <tr><td>2</td><td>1</td><td>0</td><td>1</td><td>0</td></tr> <tr><td>3</td><td>0</td><td>0</td><td>1</td><td>0</td></tr> <tr><td>4</td><td>0</td><td>1</td><td>0</td><td>1</td></tr> <tr><td>5</td><td>0</td><td>0</td><td>0</td><td>1</td></tr> <tr><td>6</td><td>1</td><td>1</td><td>1</td><td>0</td></tr> <tr><td>7</td><td>0</td><td>0</td><td>1</td><td>0</td></tr> <tr><td>8</td><td>1</td><td>1</td><td>1</td><td>0</td></tr> </table>			A	B	C	D	1	0	0	0	1	2	1	0	1	0	3	0	0	1	0	4	0	1	0	1	5	0	0	0	1	6	1	1	1	0	7	0	0	1	0	8	1	1	1
	A	B	C	D																																										
1	0	0	0	1																																										
2	1	0	1	0																																										
3	0	0	1	0																																										
4	0	1	0	1																																										
5	0	0	0	1																																										
6	1	1	1	0																																										
7	0	0	1	0																																										
8	1	1	1	0																																										

Table 5.7 — Binary logic symbols

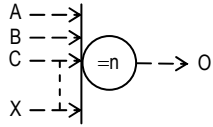
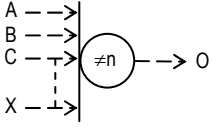
Note: Numbers in parentheses refer to explanatory notes in Clause 5.3.7.

No	Function	Definition (1)																																												
	Symbol																																													
	Truth Table (1)		Graph																																											
14	Reset dominant memory	<ul style="list-style-type: none"> • Outputs [C] and [D] are always opposite. • If input [A] equals (1) then output [C] equals (1) and output [D] equals (0). • If input [A] changes to (0) output [C] remains (1) until input [B] equals (1) then output [C] equals (1) and output [D] equals (0). • If input [B] equals (1) then output [D] equals (1) and output [C] equals (0). • If input [B] changes to (0) output [D] remains (1) until input [A] equals (1), then output [D] equals (1) and output [C] equals (0). • If inputs [A] and [B] are simultaneously equal to (1) then output [C] equals (0) and output [D] equals (1). 																																												
																																														
	<table border="1" data-bbox="305 724 500 955"> <thead> <tr> <th></th> <th>A</th> <th>B</th> <th>C</th> <th>D</th> </tr> </thead> <tbody> <tr><td>1</td><td>0</td><td>0</td><td>0</td><td>1</td></tr> <tr><td>2</td><td>1</td><td>0</td><td>1</td><td>0</td></tr> <tr><td>3</td><td>0</td><td>0</td><td>1</td><td>0</td></tr> <tr><td>4</td><td>0</td><td>1</td><td>0</td><td>1</td></tr> <tr><td>5</td><td>0</td><td>0</td><td>0</td><td>1</td></tr> <tr><td>6</td><td>1</td><td>1</td><td>0</td><td>1</td></tr> <tr><td>7</td><td>0</td><td>0</td><td>0</td><td>1</td></tr> <tr><td>8</td><td>1</td><td>1</td><td>0</td><td>1</td></tr> </tbody> </table>			A	B	C	D	1	0	0	0	1	2	1	0	1	0	3	0	0	1	0	4	0	1	0	1	5	0	0	0	1	6	1	1	0	1	7	0	0	0	1	8	1	1	0
	A	B	C	D																																										
1	0	0	0	1																																										
2	1	0	1	0																																										
3	0	0	1	0																																										
4	0	1	0	1																																										
5	0	0	0	1																																										
6	1	1	0	1																																										
7	0	0	0	1																																										
8	1	1	0	1																																										
15	Pulse duration - fixed	<ul style="list-style-type: none"> • Output [O] changes from (0) to (1) and remains (1) for prescribed time duration (t) when input [I] changes from (0) to (1). 																																												
																																														
	NONE																																													
16	Time delay - off	<ul style="list-style-type: none"> • Output [O] changes from (0) to (1) when input [I] changes from (0) to (1). • Output [O] changes from (1) to (0) after input [I] changes from (1) to (0) and has been equal to (0) for time duration (t). 																																												
																																														
	NONE																																													

Table 5.7 — Binary logic symbols

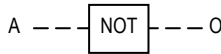
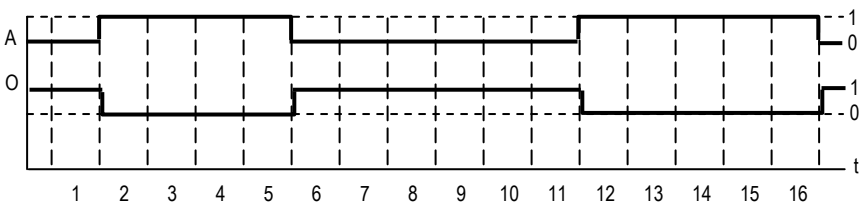
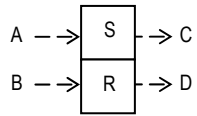
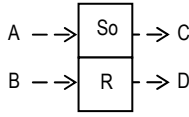
Note: Numbers in parentheses refer to explanatory notes in Clause 5.3.7.

No	Function	Definition (1)	
	Symbol		
	Truth Table (1)	Graph	
17	Time delay - on	<ul style="list-style-type: none"> Output [O] changes from (0) to (1) after input [I] changes from (0) to (1) and [I] remains (1) for prescribed time duration (t). Output [O] remains (1) until Input [I] changes to (0) or optional Reset [R] changes to (1). 	
	<p>The symbol is a square box with 't' on the left and 'GT' on the right. An input 'I' with an arrow points to the left side. An output 'O' with an arrow points to the right side. A reset input 'R' with an arrow and a diagonal slash points to the bottom-left corner.</p>		
	NONE	<p>The graph shows three signals: I, O, and R. I is a square wave. O is 0 until I transitions from 0 to 1, then jumps to 1 after a delay 't'. O remains 1 until I transitions from 1 to 0 or R transitions from 0 to 1. R is a single pulse.</p>	
18	Pulse duration - variable	<ul style="list-style-type: none"> Output [O] changes from (0) to (1) when input [I] changes from (0) to (1). Output [O] changes from (1) to (0) when Input [I] has been equal to (1) for time duration (t), Input [I] changes from (1) to (0), or optional Reset [R] changes to (1). 	
	<p>The symbol is a square box with 't' on the left and 'LT' on the right. An input 'I' with an arrow points to the left side. An output 'O' with an arrow points to the right side. A reset input 'R' with an arrow and a diagonal slash points to the bottom-left corner.</p>		
	NONE	<p>The graph shows three signals: I, O, and R. I is a square wave. O is 0 until I transitions from 0 to 1, then jumps to 1. O remains 1 until I transitions from 1 to 0 or R transitions from 0 to 1. R is a single pulse.</p>	

Table 5.8 — Electrical schematic symbols

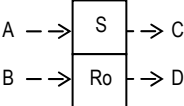
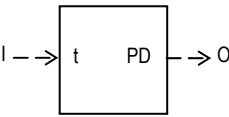
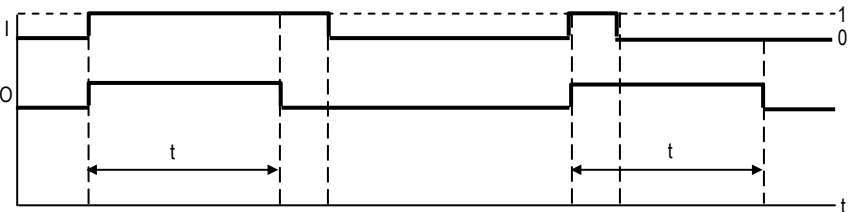
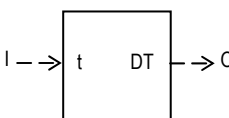
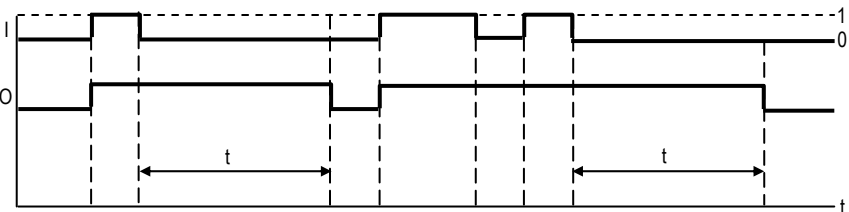
Note: Numbers in parentheses refer to explanatory notes in Clause 5.3.8.









No	Symbol (1)	Description
1	○	<ul style="list-style-type: none"> • Device wiring point. • Device wiring terminal.
2	(2) 	<ul style="list-style-type: none"> • Normally open single circuit momentary pushbutton switch. • Form A switch contact. • Stack symbols to form multi-pole switches. • Combine with symbols 5 or 6 to form toggle or rotary actuated switches.
3	(2) 	<ul style="list-style-type: none"> • Normally closed single circuit momentary pushbutton switch. • Form B switch contact. • Stack symbols to form multi-pole switches. • Combine with symbols 5 or 6 to form toggle or rotary actuated switches.
4	(2) 	<ul style="list-style-type: none"> • Normally closed/normally open double circuit momentary pushbutton switch. • Form C switch contact. • Stack symbols to form multi-pole switches. • Combine with symbols 5 or 6 to form toggle or rotary actuated switches.
5	(3) 	<ul style="list-style-type: none"> • Two-position toggle or rotary maintained position pushbutton switch actuator. • Combine with symbols 2, 3, and 4 to form single or multi-pole switches.
6	(3) 	<ul style="list-style-type: none"> • Three-position toggle or rotary maintained position pushbutton switch actuator. • Combine with symbols 2, 3, and 4 to form single or multi-pole switches.
7	(4) 	<ul style="list-style-type: none"> • Single-pole normally open toggle switch. • Form A switch contact. • Combine with symbols 10 thru 15.
8	(4) 	<ul style="list-style-type: none"> • Single-pole normally closed toggle switch. • Form B switch contact. • Combine with symbols 10 thru 15.
9	(4) 	<ul style="list-style-type: none"> • Double pole normally closed /normally open toggle switch. • Form C switch contact. • Combine with symbols 10 thru 15.
10		<ul style="list-style-type: none"> • Rotary selector switch.

Table 5.8 — Electrical schematic symbols

Note: Numbers in parentheses refer to explanatory notes in Clause 5.3.8.





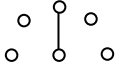





No	Symbol (1)	Description
11	(5) 	<ul style="list-style-type: none"> • Pressure switch actuator.
12	(5) 	<ul style="list-style-type: none"> • Differential pressure switch actuator.
13	(5) 	<ul style="list-style-type: none"> • Liquid level switch actuator.
14	(5) 	<ul style="list-style-type: none"> • Temperature switch actuator.
15	(5) 	<ul style="list-style-type: none"> • Flow switch actuator.
16	(5) 	<ul style="list-style-type: none"> • Foot switch actuator.
17		<ul style="list-style-type: none"> • Relay operating coil. • (*) = Relay designator, such as: <ol style="list-style-type: none"> Instrument tag number if assigned. RO1, RO2, R4, R5, MR10, etc.
18		<ul style="list-style-type: none"> • Normally open relay contact. • Form A contact.
19		<ul style="list-style-type: none"> • Normally closed relay contact. • Form B contact.
20		<ul style="list-style-type: none"> • Normally open, normally closed relay contact. • Form C contact.

Table 5.8 — Electrical schematic symbols

Note: Numbers in parentheses refer to explanatory notes in Clause 5.3.8.













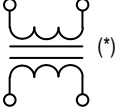

No	Symbol (1)	Description
21		<ul style="list-style-type: none"> On time delay. Moves after relay coil is energized and set time has elapsed. (*) = Set time.
22		<ul style="list-style-type: none"> Off time delay. Moves after relay coil de-energizes and set time has elapsed. (*) = Set time.
23		<ul style="list-style-type: none"> Transformer. (*) = Rating, 220/120 Vac or Vdc, etc.
24	(6) a)  b) 	<ul style="list-style-type: none"> Fuse, non-resettable. (*) = Rating, 2 A, 5 A, etc.
25		<ul style="list-style-type: none"> Thermal overload.
26		<ul style="list-style-type: none"> Circuit interrupter, 1-pole, manual reset. (*) = Rating, 10 A, 15 A, etc.
27		<ul style="list-style-type: none"> Circuit interrupter, 3-pole, manual reset. (*) = Rating, 15 A, 20 A, etc.
28		<ul style="list-style-type: none"> Circuit breaker, 1-pole, manual reset. (*) = Rating, 20A, 30A, etc.
29		<ul style="list-style-type: none"> Circuit breaker, 3-pole, manual reset. (*) = Rating, 20 A, 25 A, etc.
30		<ul style="list-style-type: none"> Bell.

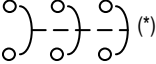
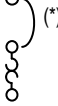
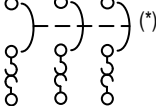
Table 5.8 — Electrical schematic symbols

Note: Numbers in parentheses refer to explanatory notes in Clause 5.3.8.

No	Symbol (1)	Description
31		<ul style="list-style-type: none"> Horn or siren.
32		<ul style="list-style-type: none"> Buzzer.
33		<ul style="list-style-type: none"> Solenoid coil.
34		<ul style="list-style-type: none"> Pilot light.
35		<ul style="list-style-type: none"> Battery
36		<ul style="list-style-type: none"> Ground
37	<p>(6)</p> <p>a) </p> <p>b) </p>	<ul style="list-style-type: none"> Connection conventions a) and b): Left = Not connected. Right = Connected.

6 Graphic symbol dimension tables

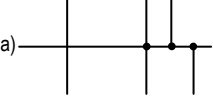
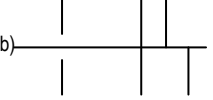
6.1 Graphic symbols dimension tables

6.1.1 The following tables provide measurement units for dimensioning the geometric shapes that are required to construct the graphic symbols.

6.1.2 The shapes in the tables are drawn twice their normal minimum size for clarity.

6.1.3 Symbols shall be drawn to a:

- a) Larger size, by increasing the dimensional unit, when required reduction of an original drawing or document results in an illegible diagram.
- b) Smaller size, by decreasing the dimensional unit, when required by space limitations of an original drawing or document.

6.1.4 All the symbols shown in Clause 5 are not individually dimensioned, but the geometric shapes required to construct all the symbols from the graphic symbol tables are included.

6.1.5 The traditional minimum size for device and function symbols from Table 6.1, a 7/16-inch (10.5-millimeter) circle, may be increased to a less commonly used 1/2-inch (12-millimeter) circle.

6.2 Measurement units

6.2.1 The dimensions are represented by measurement units (m.u.) that, as a minimum, shall have equivalent dimensions equal to:

- a) One-sixteenth inch (1/16 inch or 0.0625 inch).
- b) One and one-half millimeters (1.50 millimeters).

6.2.2 Symbols drawn in any full size diagram shall be the product of the symbol's geometric shape m.u. times a selected equivalent dimension equal to or greater than the minimum equivalent dimension.

6.2.3 Lettering shown is the minimum size allowed for full size symbols.

6.3 Dimensions for graphic symbol tables explanatory notes

6.3.1 Table 6.1 — Dimensions for measurement and control instrumentation device or function symbols, Tables 5.1.1 and 5.1.2

(1) Dimension in parentheses is for 1/2-inch (12-millimeter) option for generic circle symbol.

6.3.2 Table 6.2 — Dimensions for measurement symbols: primary elements and transmitters, Tables 5.2.1, 5.2.2, 5.2.3, 5.2.4, and 5.2.5

(1) Dimension in parentheses is for 1/2-inch (12-millimeter) option for generic circle symbol.

(2) Size as required by size of vessel as drawn or depth of application.

(3) Dip tube shown, show as required for other devices.

6.3.3 Table 6.3 — Dimensions for line symbols, Tables 5.3.1 and 5.3.2

(1) Recommended maximum signal line thickness.

(a) Signal lines are never thicker than process and equipment lines.

(2) Recommended minimum process and equipment line thickness for instrument sketches.

(3) Clearance around symbol shall be equal to half the width of the symbol.

6.3.4 Table 6.4 — Dimensions for final control elements, Tables 5.4.1, 5.4.2, 5.4.3, and 5.4.4.

(1) Table does not require any additional notes.

6.3.5 Table 6.5 — Dimensions for functional diagramming symbols, Table 5.5

(1) Graphics shown for top-to-bottom signal flow.

(2) Rotate graphics 90 degrees counterclockwise for left-to-right signal flow.

6.3.6 Table 6.6 — Dimensions for signal processing function block symbols, Table 5.6

(1) Small square graphic is used with graphics from Table 6.1.

(2) Large rectangular graphic is used with graphics from Table 6.5.

6.3.7 Table 6.7 — Dimensions for binary logic symbols, Table 5.7

(1) Input connection line dimensions are the minimum for:

(a) Five inputs.

(b) Three inputs.

(c) Two inputs.

(2) Two m.u.'s shall be added for each additional input

(3) Minimum spacing between inputs.

(4) Output signal line shall be centered on symbol.

6.3.8 Table 6.8 — Dimensions for electrical schematic symbols, Table 5.8

(1) Table does not require any additional notes.

Table 6.1 — Dimensions for Tables 5.1.1 and 5.1.2

Note: Numbers in parentheses refer to explanatory notes in Clause 6.3.1.

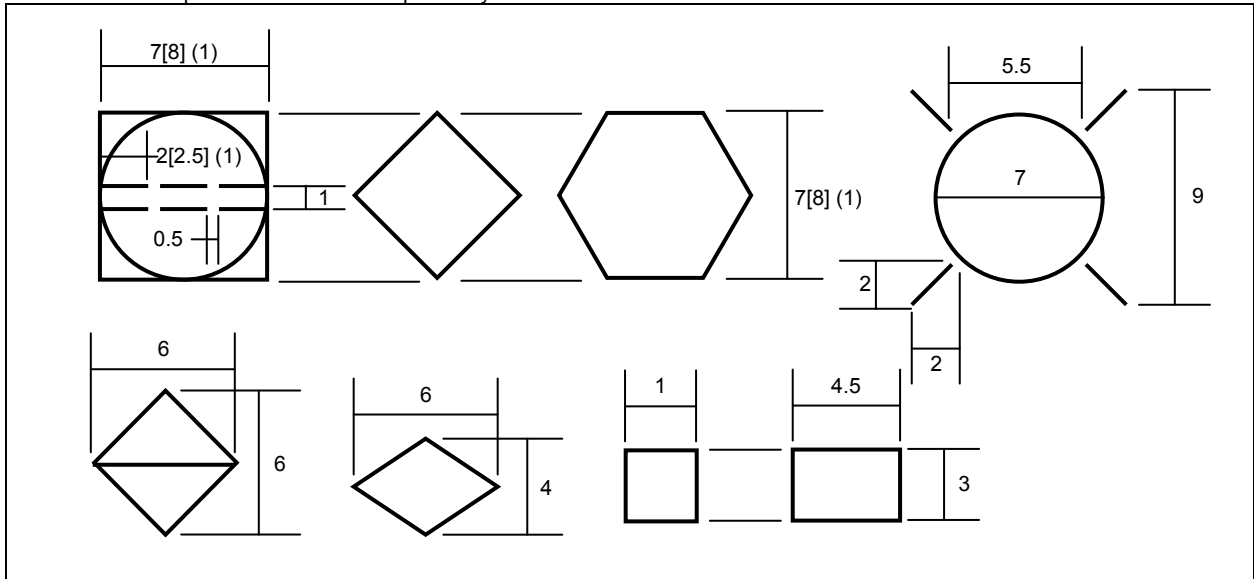

Table 6.2 — Dimensions for Tables 5.2.1, 5.2.2, 5.2.3, 5.2.4, and 5.2.5

Note: Numbers in parentheses refer to explanatory notes in Clause 6.3.2.

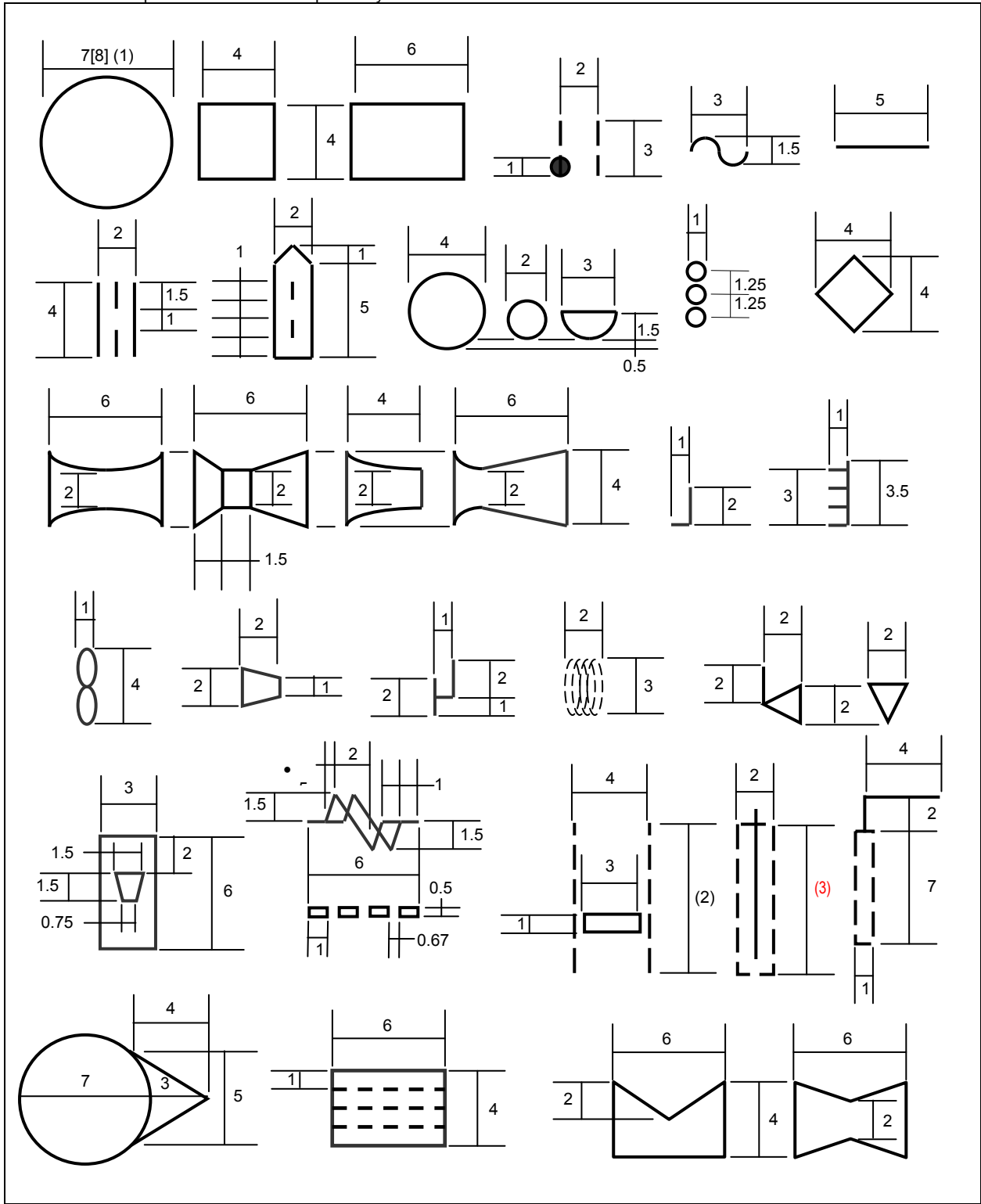

Table 6.3 — Dimensions for Tables 5.3.1 and 5.3.2

Note: Numbers in parentheses refer to explanatory notes in Clause 6.3.3.

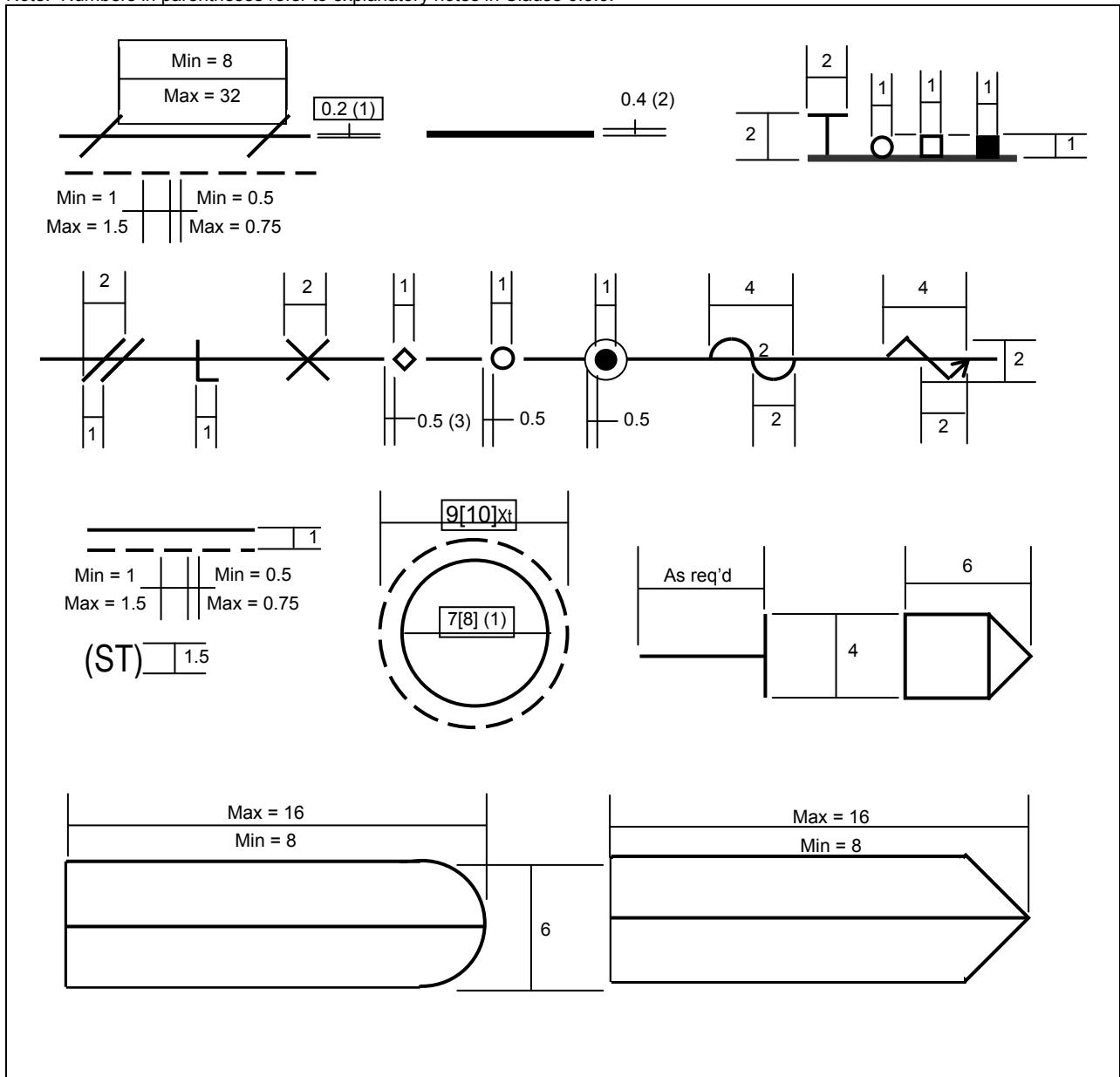

Table 6.4 — Dimensions for Tables 5.4.1, 5.4.2, 5.4.3, and 5.4.4

Note: Numbers in parentheses refer to explanatory notes in Clause 6.3.4.

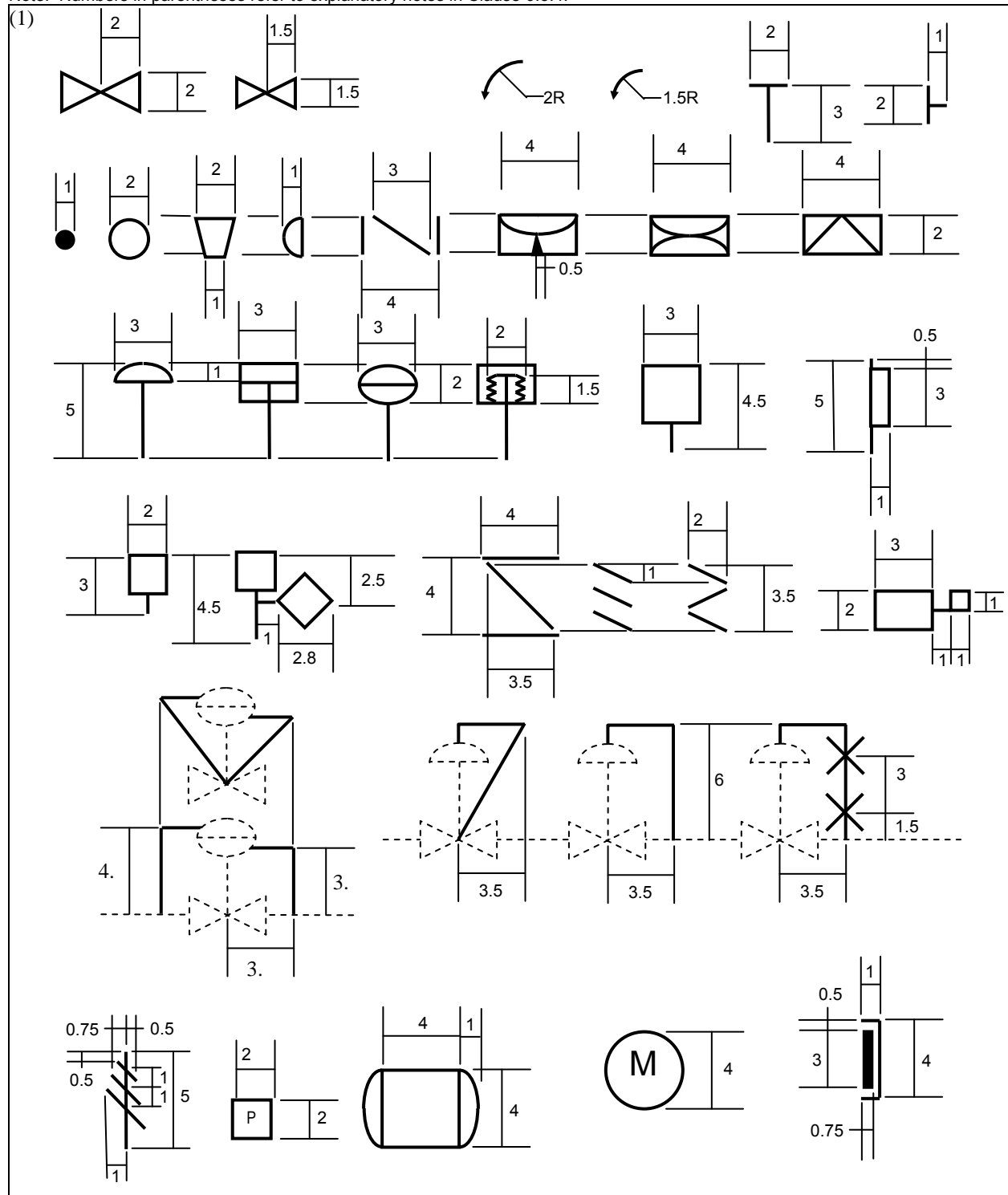

Table 6.5 — Dimensions for Table 5.5

Note: Numbers in parentheses refer to explanatory notes in Clause 6.3.5.

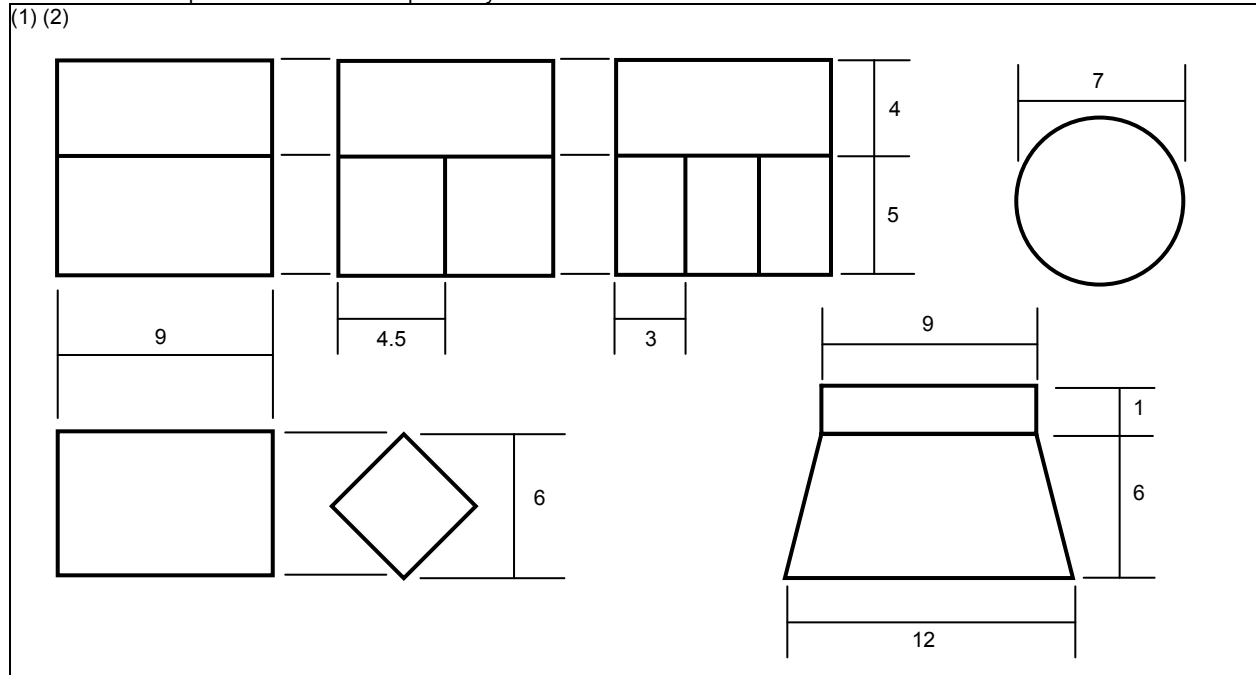

Table 6.6 — Dimensions for Table 5.6

Note: Numbers in parentheses refer to explanatory notes in Clause 6.3.6.

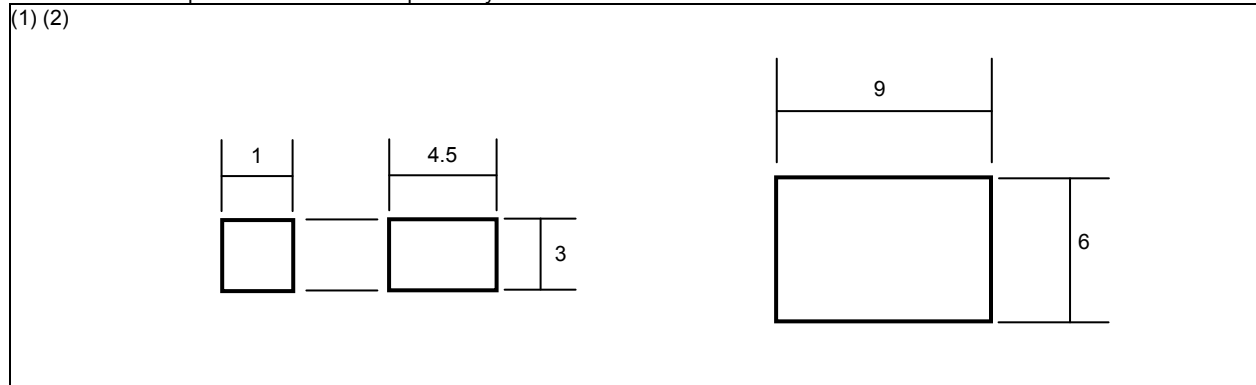

Table 6.7 — Dimensions for Table 5.7

Note: Numbers in parentheses refer to explanatory notes in Clause 6.3.7.

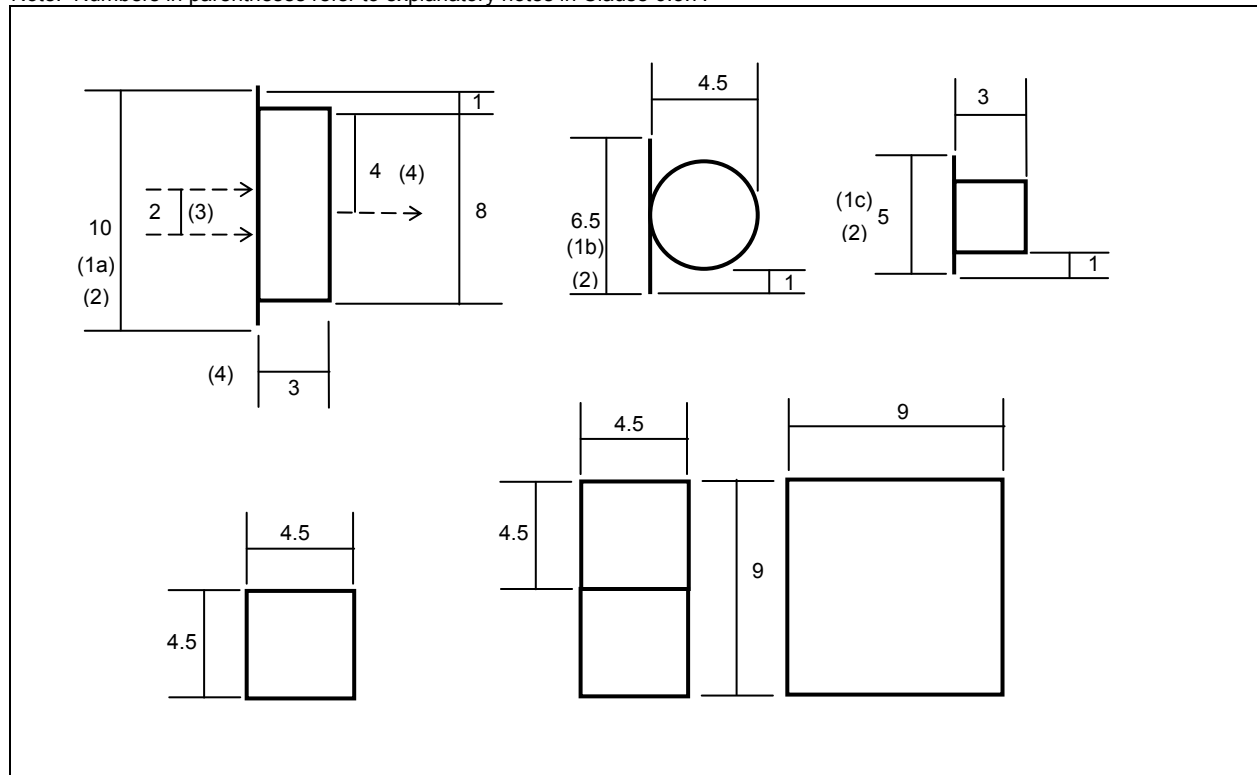
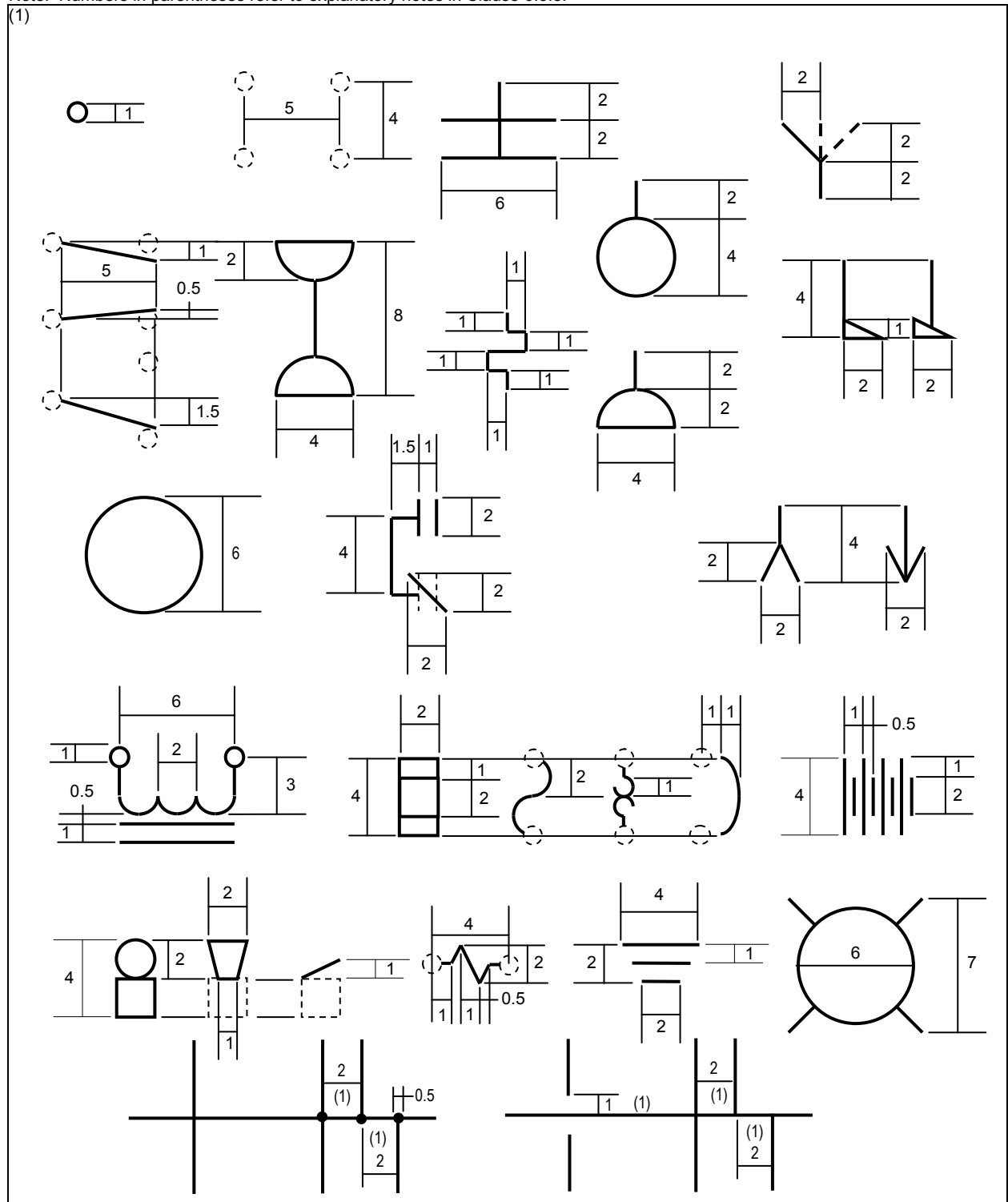

Table 6.8 — Dimensions for Table 5.8

Note: Numbers in parentheses refer to explanatory notes in Clause 6.3.8.



Annex A Identification system guidelines (informative annex)

A.1 Identification system

- A.1.1 This informative annex to the standard describes a common and almost universally used Identification System for monitoring and control instrument devices and functions that is logical, unique, and consistent in application with a minimum of exceptions, special uses, or requirements.
- A.1.2 An identification system is required to identify instrumentation in text and in sketches and drawings when used with graphic symbols as described in Annex B.
- A.1.3 The Identification System provides methods for identifying instrumentation required to monitor, control, and operate a processing plant, unit operation, boiler, machine, or any other system that requires measurement, detection, indication, control, modulation, and/or switching of variables or states.
- A.1.4 The methods shown are based on the most common ones now in use in the chemical and refining process industries.
- A.1.5 Any different methods in use in these industries should be:
 - a) Revised to conform to this annex.
 - b) Submitted to ISA (email to standards@isa.org) to determine if they are to be:
 - 1) Included in the next revision of this standard.
- A.1.6 ISA should be advised of differences that are normal practice in other industries so that these methods can be incorporated into the next revision of this standard.
- A.1.7 A multi-component monitor or control loop consists of some or all of the following (as indicated):
 - a) Measurement or detection of process variable or state (monitor and control):
 - 1) Measurement element, such as an orifice plate or thermocouple.
 - 2) Measurement transmitter or indicator:
 - a) With an integral-measuring element, such as a pressure-actuated transmitter or gauge.
 - b) With a non-integral-measuring element, such as a thermocouple-actuated temperature transmitter or gauge.
 - b) Conditioning of measurement or input signal (monitor and control):
 - 1) Calculating devices.
 - 2) Calculating functions.
 - c) Monitoring of process variable (monitor):
 - 1) Indicating or recording device.

- 2) Application software display function.
 - d) Controlling of process variable (control):
 - 1) Indicating or recording control device.
 - 2) Application software control function.
 - e) Conditioning of controller or output signal (control):
 - 1) Calculating devices.
 - 2) Calculating functions.
 - f) Modulation of controlled variable (control):
 - 1) Control valve modulation or on-off action.
 - 2) Resetting another control loop setpoint.
 - 3) Limiting another control loop output signal.
- A.1.8 A loop number is assigned to each group of components required to perform the desired function of the monitor or control scheme.
- A.1.9 A single component monitor or control loop consists of some or all of the following:
- a) Self-acting measuring and control devices, such as pressure or temperature control valves.
 - b) Self-acting measuring and control devices, such as pressure or temperature safety valves.
 - c) Single point monitoring devices, such as pressure or temperature gauges.
- A.1.10 Each single component may be assigned:
- a) A unique loop number, indexed with the plant instrumentation.
 - b) An instrument tag number, indexed separate from the primary plant instrumentation.
 - c) A coded type number.
- A.2 Instrument index
- A.2.1 Loop Identification Numbers and Instrument Identification/Tag Numbers are recorded in an Instrument Index that should be maintained for the life of the facility for the recording and control of all documents and records pertaining to the loops and their instrumentation and functions.
- A.2.2 An Instrument Index should contain references to all instrumentation data required by owner and/or government regulatory agency management of change requirements and contain, as a minimum for each loop:

- a) Loop Identification Number.
- b) Service Description.
- c) Instrument Identification/Tag Numbers.
- d) Piping and Instrumentation Diagram drawing numbers.
- e) Instrument Data Sheet numbers.
- f) Location Plan drawing numbers.
- g) Installation Detail drawing numbers.

A.3 Loop identification and instrument identification/tag numbers

- A.3.1 Loop Identification Numbers are unique combinations of letters and numbers that are assigned to each monitoring and control loop in a facility to identify the process or machine variable that is being monitored or controlled.
- A.3.2 Instrument Identification/Tag Numbers are unique combinations of letters and numbers that are formed by adding letters to the Loop Identification Number to define the purpose of each loop device and/or function that comprises a monitoring or control loop.
- A.3.3 Instrument Identification/Tag Numbers are also called Instrument Identification Number, Instrument Tag Number, Instrument Number, or Tag Number.
- A.3.4 Examples of Loop Identification and Instrument Identification/Tag Numbers for a typical loop with references to sub-clauses relevant to the components of the Loop and Instrument Identification /Tag Numbers are given in Table A.1 — Typical Loop and Instrument Identification/Tag Numbers.

A.4 Loop identification number

- A.4.1 A Loop Identification Number is a unique combination of letters and numbers that is assigned to each monitoring and control loop in a facility to identify the process or machine variable that is being monitored or controlled and should be assigned to each:
 - a) Primary monitoring and control loop.
 - b) Self-contained measuring or control device.
 - c) Secondary measuring or monitoring device if future primary loops are anticipated or if it is the standard practice of the User.
- A.4.2 Loop Identification Numbers assigned, as the basis for Instrument Identification/Tag Numbers to auxiliary or accessory devices, should be the same as the loop for which the devices are required.
- A.4.3 Loop Identification Numbers are assigned:
 - a) First Letters from Table 4.1 to identify loop Measured/Initiating Variables.

- b) Numerals to form a unique loop identity.
- c) Optional loop suffixes to identify identical loops on identical pieces of equipment or services.

A.5 Loop identification number letters

A.5.1 Loop Identification Number letters should be selected from Table 4.1 to identify the loop Measured/Initiating Variable according to one of the following methods selected by the end user:

- a) Measured/Initiating Variable: only a Measured/Initiating Variable is selected, such as analysis [A], flow [F], level [L], pressure [P], temperature [T], etc.
- b) Measured/Initiating Variable with Variable Modifier: a Measured/Initiating Variable and, when applicable, a Variable Modifier is selected, such as analysis [A], flow [F], flow quantity [FQ], level [L], pressure [P], differential pressure [PD], temperature [T], differential temperature [TD], etc.
- c) First-Letters: a Measured/Initiating Variable and, when applicable, a Variable Modifier, only if the resulting First-Letter combination defines a loop variable that can be measured directly, such as pressure differential [PD] as opposed to one that is mathematically derived, such as flow ratio [FF].

A.5.2 A Measured/Initiating Variable in combination with the safety Variable Modifier [S] is always treated as a loop variable in each of the preceding selection methods to identify self-acting devices intended to protect against emergency conditions that may be hazardous to plant personnel, plant equipment, or the environment.

A.5.3 A Measured/Initiating Variable is selected according to the physical or mechanical property that is being measured, derived or initiates an action and not according to the construction or mode of actuation of the measuring device or the property or the action it initiates:

- a) A loop that controls pressure in a vessel by manipulating gas or vapor flow to or from the vessel is a pressure [P] loop and not a flow [F] loop.
- b) A loop that measures pressure differential across:
 - 1) An orifice plate from which flow rate is calculated is a flow [F] loop and not a pressure [P] or pressure differential [PD] loop.
 - 2) A fluid interface in a vessel is a level [L] loop and not a pressure [P] or pressure differential [PD] loop.
 - 3) A filter bed or element is a pressure [P] or pressure differential [PD]-loop.

A.6 Loop identification number numerals

A.6.1 Loop Identification Number numerals should be assigned to loop measured variable letters according to one of the following methods selected by the end user:

- a) Parallel: duplicated numerical sequences for each loop variable letter or first letter combination.
 - b) Serial: single numerical sequence regardless of loop variable letter or first letter combination.
 - c) Parallel/Serial: parallel sequences for selected loop variable letters or first letter combinations and a serial sequence for the remainder.
- A.6.2 Loop Number numerical sequences are normally three or more digits, -*01, -*001, -*0001, etc. where the asterisk * can be :
- a) Any digit from zero to 9.
 - b) Coded digits related to drawing numbers, unit numbers, equipment numbers, etc.
- A.6.3 *00, *000, *0000, etc. should be used only for special, significant, or critical loops as defined by the User.
- A.6.4 000, 0000, 00000, etc. should not be used
- A.6.5 Loop Identification letters and numbers should be assigned in accordance with one of the following Loop Numbering Schemes:
- a) No. 1 Parallel – Measured/Initiating Variable.
 - b) No. 2 Parallel – Measured/Initiating Variable with Variable Modifier.
 - c) No. 3 Parallel – First Letter(s).
 - d) No. 4 Series – Measured/Initiating Variable.
 - e) No. 5 Series – Measured/Initiating Variable with Variable Modifier.
 - f) No. 6 Series – First Letter(s).
 - g) No. 7 Parallel/Series – Measured/Initiating Variable.
 - h) No. 8 Parallel/Series – Measured/Initiating Variable with Variable Modifier.
 - i) No. 9 Parallel/Series – First Letter(s).
- A.6.6 Gaps should be left in any sequence to allow for the addition of future loops.
- A.6.7 See Table A.2 — Allowable letter/number combinations for, loop numbering schemes for examples of typical Loop Number assignments.
- A.7 Optional loop number prefixes
- A.7.1 Loop Number Prefixes consisting of any combination of alpha/numeric characters that may be added to Loop Numbers to identify loop location, such as a complex, plant, or unit should be located before the Measured/Initiating Variable, for example, a flow loop in processing plant #1 might be [PP1-F*01].

A.7.2 Loop Number Prefixes should:

- a) Not necessarily be shown on drawings or indexes but covered by a general note on a legend sheet or a note on each drawing or index sheet.
- b) Be shown for all uses on drawings when more than one prefix is required by loops shown on the drawing.
- c) Be shown when used in text.

A.8 Instrument identification/tag number

A.8.1 An Instrument Identification/Tag Number is a unique combination of letters and numbers that is assigned to define the purpose of each loop device and/or function that comprises a monitoring or control loop.

A.8.2 Adding a Variable Modifier, if needed, and Succeeding Letters to the Loop Identification Number letters forms an Instrument Identification/Tag Number.

A.8.3 Instrument Identification/Tag Numbers may also be called Instrument Identification Number, Instrument Tag Number, Instrument Number, or Tag Number.

A.9 Function identification letters

A.9.1 Instrument Function Identification letters should be selected from Table 4.1, Identification Letters, and added to the Loop Identification Number letters to form an Instrument Functional Identity.

A.9.2 The sequence of letters in a Functional Identification should be in the same left-to-right order as the columns in Table 4.1:

- a) Measured or Initiating Variable, from Column 1.
- b) Modifier, if required, from Column 2.
- c) Passive Readout Function, from Column 3.
- d) Active Output Function, from Column 4.
- e) Modifier(s), if required, from Column 5.

A.9.3 Functional Identifications should use one Readout/Passive Function or one Output/Active Function to identify each device or function except, as is common for:

- a) Indicating /recording controller/switch instruments or functions in which one Passive Function, indicate [I] or record [R] and one Active Function, control [C] or switch [S], is combined to form, for example, pressure recording controller [PRC], or low-pressure indicating switch [PISL].
- b) Self-actuated control valves, in which two Active Functions control [C] and valve [V] are combined to form, for example, pressure control valve [PCV].

- A.9.4 The number of letters in a Functional Identification should be sufficient to fully describe the functionality of the device or function being identified, but generally should not exceed eight.
- A.9.5 Function Modifiers designate the relative value of the measured or initiating variable that actuates the instrument or function, for example for Function Modifier low [L]:
- a) [PSL-*01] indicates actuation by a pressure below a setpoint, normally used to indicate a process level that requires operator intervention to prevent a process trip or other unwanted result.
 - b) [PSLL-*01] indicates actuation below a setpoint lower than the previous example, normally used to indicate a process level that resulted in a process trip.
- A.9.6 A device or function common to two or more loops should be assigned a Loop Identification Letter for the loop which actuates the instrument:
- a) A solenoid valve that is actuated by a high level switch [LSH] to trip a flow control valve [FV] is assigned to the level [L] loop as an [LY] and not to the flow [F] loop as an [FY].
 - b) A high signal select device or function that selects the higher signal from a flow [F] loop and a high level [L] override loop is assigned to the flow [F]-loop as an [FY] and not to the level [L] loop as an [LY].
- A.9.7 For allowable function letter combinations see tables:
- a) A.3.1 — Allowable succeeding letter combinations for readout/passive function letters.
 - b) A.3.2 — Allowable succeeding letter combinations for output/active function letters.
- A.10 Loop number and instrument/tag number suffixes
- A.10.1 A Loop Number Suffix may be added to a Loop Number to identify identical loops on identical equipment in the same processing unit when the service or equipment is assigned the same equipment identification number with a suffix, such as reactors, heat exchangers, and pumps.
- A.10.2 A Loop Suffix may use alphabetic or numeric characters according to User/Owner established practice and should be located after the Loop Identification Number as illustrated in Table A.1.
- A.10.3 A Loop Suffix may be located after the Loop Letters when user, owner, computer, or microprocessor information systems will not allow alphabetic or additional numeric characters in the numerical part of an identification number:
- A.10.4 An Identification/Tag Number Suffix should be added to Instrument Identification/Tag Numbers in the loop to designate two or more similar devices or functions:
- a) Case 1 – in different services, such as control valves that direct flow to different places, or auxiliary devices, such as those that perform different functions.
 - b) Case 2 – in the same service, such as control valves that direct flow to the same place, or auxiliary devices, such as those that perform the same function.
- A.10.5 Additional Identification/Tag Number Suffixes should be added when two or more similar devices or functions are also duplicated, using alternating alpha/numeric characters.

A.10.6 For examples of Loop Number and Instrument/Tag Number Suffixes, see Table A.4.

A.11 Optional punctuation marks in identification numbers

A.11.1 Punctuation marks, hyphens, slashes, etc., may be used to separate sections of identification numbers as required by:

- a) User/Owner.
- b) Database management system.
- c) Control system application software.

A.11.2 Punctuation is recommended for use between:

- a) An alphabetic Loop Number prefix and Measured/Initiating Variable letters: [**AB-P*05**].
- b) Loop Number numerals and a numeric Loop Number suffix: [**AB-P*05-1**, **AB-P*05-2**],
- c) Loop Number numerals and Tag Number suffix: [**10-P*05-A1A** or **10-P*05-1A1**]
- d) A Loop Number suffix and Tag Number suffix: [**10PT*05A-A** or **10PT*05-1-A**].

A.11.3 Punctuation is optional for use between:

- a) A Numeric Loop Number prefix and Measured/Initiating Variable letter: [**10-P*05**].
- b) A Measured /Initiating Variable letter and Loop Number numerals: [**10P*-05**].

A.11.4 Punctuation should not be used between:

- a) Loop Number numerals and an alphabetic Loop Number suffix: [**10P*05A**].
- b) Additional Tag Number suffixes: [**10PV*05A-A1A**].

A.11.5 Backslashes are normally used between Functional Identification letters for multifunction devices when used in text, [**TR/TSH-*108**].

A.12 Multivariable, multifunction, and multipoint loops

A.12.1 Loops that have more than one input and/or output are classified as:

- a) **Multivariable:** when two or more Measured/Initiating Variables of the same or different kinds generate one Output/Active Function and one or more Readout/Passive Functions.
- b) **Multifunction:** when one Measured/Initiating Variable generates two or more Output/Active or Readout/Passive Functions.
- c) **Multivariable/multifunction:** when two or more Measured/Initiating Variables of the same or different kinds generates two or more Output/Active or Readout/Passive Functions..

- d) Multipoint: when two or more Measured/Initiating Variables of the same or different kinds generate two or more Readout/Passive Functions.
- A.12.2 Multivariable Loop Number assignments using pressure [P-*07], temperature [T-*03], and speed [S-*02] loops, for example, should be either:
- a) Alphabetically ordered Measured/Initiating Variables with Loop Number numerals the same as or different from the leading Measured/Initiating Variable: [PTS-*07] or [PTS-*10].
 - b) Multivariable Measured/Initiating Variable [U]: [U-*01]
- A.12.3 Multivariable Loop components should be assigned Instrument/Tag Numbers as an example for:
- a) Inputs: [PT-*07], [TT-*03], and [ST-*02].
 - b) Output: either [PTSV*07], [PTSV-*10], or [UV-*01].
- A.12.4 Multifunction Instrument/Tag Number assignments using a flow [F] loop with indicating [I], controlling [C], and switching [S] functions, for example, should be either [FICS-*05].or [FU-*05].
- A.12.5 Multivariable/multifunction Loop Number assignments using flow [F-*05], pressure [P-*07], temperature [T-*03], and speed [S-*02] loops, for example, should be either:
- a) Alphabetically ordered Measured/Initiating Variables with Loop Number numerals the same as or different from the leading Measured/Initiating Variable: [FPTS-*05] or [FPTS-*10].
 - b) Multivariable Measured/Initiating Variable [U]: [U-*01]
- A.12.6 Multivariable/Multifunction Loop components should be assigned Instrument/Tag Numbers as an example for:
- a) Inputs: [FT-*05], [PT-*07], [TT-*03], and [ST-*02].
 - b) Output: either [PTSV*07] or [PTSV-*10], and [FV-*05], or [UV-*01A] and [UV-*01B].
- A.12.7 Multipoint Loop and Instrument/Tag Number identification letter assignments for :
- a) Single Measured/Initiating Variable, using temperature [T] as an example, should be:
 - 1) Loop Number: [T-*11].
 - 2) Input: [TE-*11-01], [TE-*11-02], etc. or [TJE]-*11-01, [TJE-*11-02], etc.
 - 3) Readout: [TI-*11] or [TJI-*11]
 - 4) Readout point; [TI-*11-01], [TI-*11-02], etc. [TJI-*11-01], [TJI-*11-02], etc.
 - b) Multiple Measured/Initiating Variables, using pressure [P] and temperature [T] as an example, should be:
 - 1) Loop Number: [PT-*11] or [U-*01].
 - 2) Input: [PT-*11-01], [TE-*11-02], etc. or [PJT-*11-01], [TJE-*11-02], etc.
 - 3) Readout: [PTI-*11] or [PTJI-01] or [UI-*01] or [UJI-*01].

- 4) Readout point: [PI-11-01], [TI-11-02], etc. or [PJI-11-01], [TJI-11-02], etc.

A.13 Secondary, auxiliary, and accessory instrumentation

A.13.1 Secondary instrumentation, such as level glasses, pressure gauges, and thermometers, may be assigned either:

- a) An Instrument Identification/Tag Number which should be either of:
 - 1) LG-*01, PG-*01, TG-*01, etc.
 - 2) LI-*01, PI-*01, TI-*01, etc.
- b) A generic identification number that defines the instrument type and range which should be either of:
 - 1) LG-24 – 0-24in, PG-200 – 0-200psig, TG-250 – 0-250degF.
 - 2) LI-24 – 0-24in, PI-200 – 0-200psig, TI-250 – 0-250degF.

A.13.2 Readout/Passive Function letter for glass, gauge, or viewing device [G] is recommended for use for flow glasses [FG], level glasses or gauges [LG], pressure gauges [PG], thermometers [TG], etc., to avoid database management problems with primary flow indicators [FI], level indicators [LI], pressure indicators [PI], temperature indicators [TI], etc.

A.13.3 Current common usage is [FG] and [LG] for flow and level and [PI] and [TI] for pressure and temperature.

A.13.4 Auxiliary instrumentation, such as signal computing and converting relays, solenoid valves, and analyzer sample conditioning units, are identified by a loop Measured/Initiating Variable and the Output/Active Function [Y], as in, [FY], [PY], etc.

A.13.5 Instrumentation accessories, such as flowmeter runs, purge meters, air sets, seal pots, etc., that may or may not be explicitly shown on a diagram should be tagged in the Instrument index.

A.13.6 A purge meter for pressure transmitter [PT-*23] may be tagged:

- a) With the Instrument Identification/Tag Number of the instrument they serve followed by a word or phrase, that describes their function, for example: [PT-*23 PURGE].
- b) With an Instrument Identification/Tag Number as a component of the loop: [PX-*23] with a note outside the bubble or in the note section of the drawing describing its use.
- c) As a secondary instrument:
 - 1) [FI-*11] if not controlling purge flow.
 - 2) [FICV-*11] if controlling purge flow.

A.13.7 Assignment of a tag number to an accessory;

- a) Means that it must be listed in the instrument index.

- b) Does not mean that it must be shown on a P&ID.
- c) Means that it must be tagged on a P&ID if shown.

A.13.8 The identification methods chosen for a project should be documented in the Owners or Users engineering and design standards and guidelines and on a drawing or document legend sheet.

A.14 System identification

A.14.1 Instrumentation is often assembled into systems for various reasons, such as ease of purchase, ease of application, and compatibility, and these systems may need to be identified on drawings and in text.

A.14.2 Some of the more common instrumentation systems and the system codes often used to identify them are:

- a) ACS = Analyzer Control System
- b) BMS = Burner Management System
- c) CCS = Computer Control System
- d) CEMS = Continuous Emissions Monitoring System
- e) DCS = Distributed Control System
- f) MMS = Machine Monitoring System
- g) PCCS = Personal Computer Control System
- h) PLC = Programmable Logic Controller
- i) SIS = Safety Instrumented System
- j) VMS = Vibration Monitoring System

A.14.3 Suffixes may be added to the instrumentation system codes [SC]:

- a) [SC 1, SC 2], etc., when more than one system is used in a complex.
- b) [SC-M, SC-L], when main and local systems are used in a unit.
- c) [SC-'unit identifier'], when system is dedicated to a single unit in a multi-unit facility.

A.15 Identification system guideline tables

A.15.1 Identification System guideline tables are based on the most common usages to be found in the chemical and refining process industries.

A.15.2 The tables are intended to be a guide to constructing such tables based on a User's actual requirements.

A.15.3 Loops are based on the variable being measured and not on the variable being manipulated.

A.15.4 Instrument tag numbers are based on the loop number and the functionality required of the loop components.

A.16 Identification system guideline table explanatory notes

The following notes, indicated in Tables A.1, A.2, A.3, and A.4 by parentheses, are used as an aid in understanding the meanings and usage of the lettering.

A.16.1 Table A.1 — Typical Loop and Instrument Identification/Tag Numbers

- (1) Replace asterisk in Loop Numbers with any digit from 0 to 9 or any combination of digits.
- (2) Numbers in brackets indicate sub-clause relevant to line description.

A.16.2 Table A.2 — Allowable letter/number combinations for loop numbering schemes.

- (1) First Letters do not include all possibilities.
- (2) Replace asterisk in Loop Number with any digit from 0 to 9 or any combination of numerals.
- (3) Variable Modifier safety instrumented system [Z] is technically not a direct-measured variable but is used to identify loops in a Safety Instrumented System. And because of the critical nature of such loops, any Measured/Initiating Variable followed by [Z], such as [FZ], [PZ], and [TZ], should be considered as Measured/ Initiating Variables in all Loop Identification Number construction schemes
 - (a) An alternate method for identifying Safety Instrumented System loops is to append [(SIS)] outside the bubbles of Safety Instrumented System loops and as a prefix or suffix to the Loop Number when used in text. For example, Loop Numbers for pressure and temperature loops in an SIS may be [(SIS)P-*01] or [T-*09(SIS)].
- (4) Users should assign, as needed, meanings to:
 - (a) Users Choice Measured/Initiating Variable letters [C], [D], [G], [M], [N], and [O].
 - (b) Variable Modifier letter blanks [A], [B], [C], [E], [G], [H], [I], [L], [M], [N], [O], [P], [R], [T], [U], [V], and [W].
- (5) Variable Modifier safety [S] is technically not a direct-measured variable but is used to identify self-actuated emergency protective primary and final control elements only when used in conjunction with Measured/Initiating Variables flow [F], pressure [P] or temperature [T]. And because of the critical nature of such devices, [FS], [PS], and [TS] should be considered as Measured/ Initiating Variables in all Loop Identification Number construction schemes:
 - (a) Shall not be used to identify Safety Instrumented Systems and components.
- (6) Measured/Initiating Variables [V], [W], or [Z] when used in a Safety Instrumented System and:
 - (a) Not axially oriented should use [VZ], [WZ], and [ZZ] as Measured/Initiating Variables.

(b) Axially oriented should use [VZX], [VZY], [VZZ], and [WZX], [WZY], [WZZ] and [ZZX], [ZZY], [ZZZ] as Measured/Initiating Variables.

A.16.3 Tables A.3.1 and A.3.2 — Allowable succeeding letter combinations for readout/passive and output/active function letters and first-letters.

- (1) Cells marked NA indicate not allowable combinations.
- (2) First Letters are assigned according to Table A.2.
- (3) Function Modifiers are added where indicated to right of alarm function combinations.
- (4) Users should assign, as needed, meanings to:
 - (a) Users Choice Function letters [B] and [N].
 - (b) Readout/Passive Function blanks [C], [D], [F], [H], [J], [K], [M], [S], [T], [V], [Y], and [Z].
 - (c) Output/Active Function blanks [A], [D], [E], [F], [G], [H], [I], [J], [L], [M], [O], [P], [Q], [R], and [W].
 - (d) Function Modifier blanks [A], [E], [F], [G], [I], [J], [K], [P], [Q], [T], [U], [V], [W], [Y], and [Z].
- (5) Readout/Passive Function [G] (glass, gauge) is used for local direct connected devices, such as flow sight glasses, level glasses, pressure gauges, thermometers weigh scales and position indicators. These devices provide a simple view of a process condition.
 - (a) Readout/Passive Function [I] (indicate) may continue to be used in facilities where it is currently used.
- (6) Pressure rupture disc [PSE] and fusible link [TSE] apply to all sensors or primary elements intended to protect against emergency pressure or temperature conditions.
- (7) The combinations in the [C] column are used for:
 - (a) Discrete single case instruments that do not have operator-visible indication of measured variable, setpoint, or output signal.
 - (b) Controller functions configured in shared display, shared control systems where indication and recording are configurable functions available on demand.
- (8) The combinations in the [IC] and [RC] columns indicate the order to be followed in forming the Functional Identification of a controller device or function that also provides indication or recording.
- (9) The combinations in the [CV] column indicate the order to be followed in forming the Functional Identification for self-actuated control valves.
- (10) Flow safety valve [FSV] applies to valves intended to protect against an emergency excess flow or loss of flow condition. Pressure safety valve [PSV], and temperature safety valve [TSV] apply to valves intended to protect against emergency pressure and temperature conditions
- (11) A self-actuated pressure valve that prevents operation of a fluid system at a higher-than-desired pressure by bleeding fluid from the system is a backpressure control valve [PCV], even if the valve is not normally used.

(a) This valve should be designated a pressure safety valve [PSV] if it protects against emergency conditions hazardous to personnel and/or equipment that are not expected to arise normally.

A.16.4 Table A.4 — Loop and Identification Tag Number suffixes

- (1) Replace asterisk in Loop Numbers with any digit from 0 to 9 or any combination of numerals.
- (2) Punctuation shown is recommended.
- (3) Case 1 and Case 2 may be reversed or a single case may be used for all applications.

Table A.1 — Typical Loop and Instrument Identification/Tag Numbers

Note: Numbers in parentheses refer to explanatory notes in Clause A.16.1.

Example: Differential pressure loop with a low alarm.															
Typical Measured/Initiating Variable Loop Number – 10-P-*01A (1) (Loop Numbering Schemes: 1, 4, or 7)															
	10	-	P	-	*01	A							Loop Identification Number	[A.4] (2)	
						A							A	Loop Number Suffix	[A.10]
					*01								*01	Loop Identification Number numerals	[A.6]
				-									-	Optional Punctuation	[A.11]
			P										P	Measured/Initiating Variable letter	[A.5]
		-											-	Optional Punctuation	[A.11]
	10												10	Loop Number Prefix	[(A.7)]
Typical First Letters Loop Number – AB-PD-*01A (1) (Loop Numbering Schemes: 2, 3, 5, 6, 8, or 9)															
	AB	-	P	D	-	*01	A						Loop Identification Number	[A.4] (2)	
							A						A	Loop Number Suffix	[A.10]
						*01							*01	Loop Identification Number numerals	[A.6]
				-									-	Optional Punctuation	[A.11]
				D									D	Variable Modifier letter	[A.5]
			P										P	Measured/Initiating Variable letter	[A.5]
			P	D									PD	First Letters	[A.5]
		-											-	Recommended Punctuation	[A.11]
	AB												AB	Loop Number Prefix	[A.7]
Typical Instrument Identification/Tag Number – 10-PDAL-*01A-1A1 (1)															
	10	-	P	D	A	L	-	*01	A	-	1	A1	Instrument Identification/Tag Number	[A.8] (2)	
												A1	Additional Tag Number Suffixes	[A.10]	
											1	1	First Tag Number Suffix	[A.10]	
		-										-	-	Recommended Punctuation	[A.11]
												A	A	Loop Number Suffix	[A.10]
								*01					*01	Loop Identification Number numerals	[A.6]
							-						-	Optional Punctuation	[A.11]
						L							L	Function Modifier letter	[A.9]
					A								A	Function Identification letter	[A.9]
					A	L							AL	Succeeding Letters	[A.9]
				D									D	Variable Modifier letter (if required)	[A.5]
			P										P	Measured/Initiating Variable letter	[A.5]
			P	D	A	L							PDAL	Function Identification letters	[A.9]
		-											-	Optional Punctuation	[A.11]
	10												10	Loop Number Prefix	[A.7]

Table A.2.1 — Allowable letter/number combinations for loop numbering schemes and first letters A to O

Note: Numbers in parentheses refer to explanatory notes in Clause A.16.3.

First Letters (1) Measured/Initiating Variables w/ and w/o Modifiers (4b)		Scheme 1	Scheme 2	Scheme 3	Scheme 4	Scheme 5	Scheme 6	Scheme 7		Scheme 8		Scheme 9	
		Parallel (2)			Serial (2)			Parallel (2)	Serial (2)	Parallel (2)	Serial (2)	Parallel (2)	Serial (2)
		Meas / Init Variable		First Letters	Meas / Init Variable		First Letters	Measured/Initiating Variable				First Letters	
		w/o Mod.	w/Mod.		w/o Mod.	w/Mod.		w/o Modifiers		w/Modifiers			
A	2Analysis	A*01	A*01	A*01	A*01	A*01	A*01	A*01		A*01	A*01	AZ*02	A*01
AZ	Analysis(SIS) (3)		AZ*02	AZ*01		AZ*02	AZ*02				AZ*01		
B	Burner, Combustion	B*01	B*01	B*01	B*02	B*03	B*03		B*01		B*01	BZ*02	B*01
BZ	Burner, Combustion(SIS) (3)		BZ*02	BZ*01		BZ*04	BZ*04				BZ*02		
C	User's Choice (4a)	C*01	C*01	C*01	C*03	C*05	C*05		C*02		C*03		C*03
D	User's Choice (4a)	D*01	D*01	D*01	D*04	D*06	D*06		D*03		D*04		D*04
E	Voltage	E*01	E*01	E*01	E*05	E*07	E*07		E*04		E*05		E*05
EZ	Voltage(SIS) (3)		E*02	EZ*01		E*08	E*08				EZ*06		EZ*06
F	Flow, Flow Rate	F*01	F*01	F*01	F*06	F*09	F*09	F*01		F*01	F*01		F*01
FF	Flow Ratio		FF*02	FF*01		FF*10	FF*10				FF*01		
FQ	Flow Total		FQ*03	FQ*01		FQ*11	FQ*11				FQ*01		
FS	Flow Safety (5)		FS*04	FS*01		FS*12	FS*12				FS*01		
FZ	Flow(SIS) (3)		FZ*05	FZ*01		FZ*13	FZ*13				FZ*01		
G	User's Choice (4a)	G*01	G*01	G*01	G*07	G*14	G*14		G*05		G*07		G*07
H	Hand	H*01	H*01	H*01	H*08	H*15	H*15		H*06		H*08		H*08
HZ	Hand(SIS) (3)		HZ*01	HZ*01		HZ*16	HZ*16	HZ*09	HZ*09				
I	Current	I*01	I*01	I*01	I*09	I*17	I*17		I*07		I*10		I*10
IZ	Current(SIS) (3)		IZ*02	IZ*01		IZ*18	IZ*18				IZ*11		IZ*11
J	Power	J*01	J*01	J*01	J*10	J*19	J*19		J*08		J*12		J*12
JQ	Power Totalize		JD*02	JD*01		JD*20	JD*20				JQ*13		JQ*13
JZ	Power(SIS) (3)		JZ*03	JZ*01		JZ*21	JZ*21				JZ*14		JZ*14
K	Time, Schedule	K*01	K*01	K*01	K*11	K*22	K*22		K*09		K*15		K*15
KQ	Time Totalize		KQ*02	KQ*01		KQ*23	KQ*23				KQ*16		KQ*16
L	Level	L*01	L*01	L*01	L*12	L*24	L*24	L*01		L*01	LZ*02		L*01
LZ	Level(SIS) (3)		LZ*02	LZ*01		LZ*25	LZ*25						LZ*01
M	User's Choice (4a)	M*01	M*01	M*01	M*13	M*26	M*26		M*10		M*17		M*17
N	User's Choice (4a)	N*01	N*01	N*01	N*14	N*27	N*27		N*11		N*18		N*18
O	User's Choice (4a)	O*01	O*01	O*01	O*15	O*28	O*28	O*12	O*19	O*19	O*19	O*19	

Table A.2.2 — Allowable letter/number combinations for loop numbering schemes and first letters P to VZZ

Note: Numbers in parentheses refer to explanatory notes in Clause A.16.3.

First Letters (1) Measured/Initiating Variables w/ and w/o Modifiers (4b)		Scheme 1	Scheme 2	Scheme 3	Scheme 4	Scheme 5	Scheme 6	Scheme 7		Scheme 8		Scheme 9	
		Parallel (2)			Serial (2)			Parallel (2)	Serial (2)	Parallel (2)	Serial (2)	Parallel (2)	Serial (2)
		Meas / Init Variable		First Letters	Meas / Init Variable		First Letters	Measured/Initiating Variable				First Letters	
		w/o Mod.	w/Mod.		w/o Mod.	w/Mod.		w/o Modifiers		w/Modifiers			
P	Pressure	P-*01	P-*01	P-*01	P-*16	P-*29	P-*29	P-*01			P-*01		P-*01
PD	Pressure Differential		PD-*02	PD-*01		PD-*30	PD-*30				PD-*02		PD-*01
PF	Pressure Ratio		PF-*03	PF-*01		PF-*31	PF-*31				PF-*03		PF-*01
PJ	Pressure Scan		PJ-*04	PJ-*01		PJ-*32	PJ-*32				PJ-*04		PJ-*01
PK	Pressure Rate of Change		PK-*05	PK-*01		PK-*33	PK-*33				PK-*05		PK-*01
PS	Pressure Safety (5)		PS-*06	PS-*01		PS-*34	PS-*34				PS-*06		PS-*01
PZ	Pressure(SIS) (3)		PZ-*07	PZ-*01		PZ-*35	PZ-*35				PZ-*07		PZ-*01
Q	Quantity	Q-*01	Q-*01	Q-*01	Q-*17	Q-*36	Q-*36		Q-*13		Q-*20		Q-*20
QQ	Quantity Totalize		QQ-*02	QQ-*01		QQ-*37	QQ-*37				QQ-*21		QQ-*21
R	Radiation	R-*01	R-*01	R-*01	R-*18	R-*38	R-*38		R-*14		R-*22		R-*22
RQ	Radiation Totalize		RQ-*02	RQ-*01		RQ-*39	RQ-*39				RQ-*23		RQ-*23
RZ	Radiation(SIS) (3)		RZ-*03	RZ-*01		RZ-*40	RZ-*40				RZ-*24		RZ-*24
S	Speed, Frequency		S-*01	S-*01		S-*01	S-*19				S-*41		S-*41
SZ	Speed(SIS) (3)	SZ-*02	SZ-*01	SZ-*42	SZ-*42	SZ-*26	SZ-*26	SZ-*26	SZ-*26				
T	Temperature	T-*01	T-*01	T-*01	T-*20	T-*43	T-*43	T-*01			T-*01		T-*01
TD	Temperature Differential		TD-*02	TD-*01		TD-*44	TD-*44				TD-*02		TD-*01
TF	Temperature Ratio		TF-*03	TF-*01		TF-*45	TF-*45				TF-*03		TF-*01
TJ	Temperature Scan		TJ-*04	TJ-*01		TJ-*46	TJ-*46				TJ-*04		TJ-*01
TK	Temperature Rate of Change		TK-*05	TK-*01		TK-*47	TK-*47				TK-*05		TK-*01
TS	Temperature Safety (5)		TS-*06	TS-*01		TS-*48	TS-*48				TS-*06		TS-*01
TZ	Temperature(SIS) (3)		TZ-*07	TZ-*01		TZ-*49	TZ-*49				TZ-*06		TZ-*06
U	Multivariable	U-*01	U-*01	U-*01	U-*21	U-*50	U-*50		U-*16		U-*27		U-*27
UJ	Multivariable Scan		UJ-*02	UJ-*01		UJ-*51	UJ-*51				UJ-*28		UJ-*28
UZ	Multivariable(SIS) (3)		UZ-*03	UZ-*01		UZ-*52	UZ-*52				UZ-*29		UZ-*29
V	Vibration, Machinery Analysis	V-*01	V-*01	V-*01	V-*22	V-*53	V-*53		V-*17		V-*30		V-*30
VZ	Vibration(SIS) (3) (6a)		VZ-*02	VZ-*01		VZ-*54	VZ-*54				VZ-*31		VZ-*31
VX	Vibration X-Axis		VX-*03	VX-*01		VX-*55	VX-*55				VX-*32		VX-*32
VY	Vibration Y-Axis		VY-*04	VY-*01		VY-*56	VY-*56				VY-*33		VY-*33
VZ	Vibration Z-Axis		VZ-*05	VZ-*01		VZ-*57	VZ-*57				VZ-*34		VZ-*34
VZX	Vibration X-Axis(SIS) (3) (6b)		VZX-*06	VZX-*01		VZX-*58	VZX-*58				VZX-*35		VZX-*35
VZY	Vibration Y-Axis(SIS) (3) (6b)		VZY-*07	VZY-*01		VZY-*59	VZY-*59				VZY-*36		VZY-*36
VZZ	Vibration Z-Axis(SIS) (3) (6b)		VZZ-*08	VZZ-*01		VZZ-*60	VZZ-*60				VZZ-*37		VZZ-*37

Table A.2.3 — Allowable letter/number combinations for loop numbering schemes and first letters W to ZDZ

Note: Numbers in parentheses refer to explanatory notes in Clause A.16.3.

First Letters (1) Measured/Initiating Variables w/ and w/o Modifiers (4b)		Scheme 1	Scheme 2	Scheme 3	Scheme 4	Scheme 5	Scheme 6	Scheme 7		Scheme 8		Scheme 9	
		Parallel (2)			Serial (2)			Parallel (2)	Serial (2)	Parallel (2)	Serial (2)	Parallel (2)	Serial (2)
		Meas / Init Variable		First Letters	Meas / Init Variable		First Letters	Measured/Initiating Variable				First Letters	
		w/o Mod.	w/Mod.		w/o Mod.	w/Mod.		w/o Modifiers		w/Modifiers			
W	Weight, Force	W-*01	W-*01	W-*01	W-*23	W-*61	W-*61	W-*18			W-*38	W-*38	
WZ	Force(SIS) (3) (6a)		WZ-*02	WZ-*01		WZ-*62	WZ-*62				WZ-*39	WZ-*39	
WD	Weight Differential		WD-*03	WD-*01		WD-*63	WD-*63				WD-*40	WD-*40	
WF	Weight Ratio		WF-*04	WF-*01		WF-*65	WF-*65				WF-*41	WF-*41	
WK	Weight Loss (Gain)		WK-*05	WK-*01		WK-*66	WK-*66				WK-*42	WK-*42	
WQ	Weight Total		WQ-*06	WQ-*01		WQ-*67	WQ-*67				WQ-*43	WQ-*43	
WX	Force X Axis		WX-*07	WX-*01		WX-*68	WX-*68				WX-*44	WX-*44	
WY	Force Y Axis		WY-*08	WY-*01		WY-*69	WY-*69				WY-*45	WY-*45	
WZ	Force Z Axis		WZ-*09	WZ-*01		WZ-*70	WZ-*70				WZ-*46	WZ-*46	
WZX	Force X Axis(SIS) (3) (6b)		WZX-*10	WZX-*01		WZX-*71	WZX-*71				WZX-*47	WZX-*47	
WZY	Force Y Axis(SIS) (3) (6b)		WZY-*11	WZY-*01		WZY-*72	WZY-*72				WZY-*48	WZY-*48	
WZZ	Force Z Axis(SIS) (3) (6b)		WZZ-*12	WZZ-*01		WZZ-*73	WZZ-*73				WZZ-*49	WZZ-*49	
X	Unclassified		X-*01	X-*01		X-*01	X-*24				X-*74	X-*74	X-*19
Y	Event, State, Presence	Y-*01	Y-*01	Y-*01	Y-*25	Y-*75	Y-*75	Y-*20			Y-*51	Y-*51	
YZ	Event, State(SIS) (3)		YZ-*02	YZ-*01		YZ-*76	YZ-*76		YZ-*52	YZ-*52			
Z	Position, Dimension	Z-*01	Z-*01	Z-*01	Z-*26	Z-*77	Z-*77	Z-*21			Z-*53	Z-*53	
ZZ	Position(SIS) (3) (6a)		ZZ-*02	ZZ-*01		ZZ-*78	ZZ-*78				ZX-*54	ZX-*54	
ZX	Position X Axis		ZX-*03	ZX-*01		ZX-*79	ZX-*79				ZY-*55	ZY-*55	
ZY	Position Y Axis		ZY-*04	ZY-*01		ZY-*80	ZY-*80				ZZ-*56	ZZ-*56	
ZZ	Position Z Axis		ZZ-*05	ZZ-*01		ZZ-*81	ZZ-*81				ZZ-*57	ZZ-*57	
ZZX	Position X Axis(SIS) (3) (6b)		ZZX-*06	ZZX-*01		ZZX-*82	ZZX-*82				ZZX-*58	ZZX-*58	
ZZY	Position Y Axis(SIS) (3) (6b)		ZZY-*07	ZZY-*01		ZZY-*83	ZZY-*83				ZZY-*59	ZZY-*59	
ZZZ	Position Z Axis(SIS) (3) (6b)		ZZZ-*08	ZZZ-*01		ZZZ-*84	ZZZ-*84				ZZZ-*60	ZZZ-*60	
ZD	Position Difference		ZD-*09	ZD-*01		ZD-*85	ZD-*85				ZD-*61	ZD-*61	
ZDX	Position Difference X Axis		ZDX-*10	ZDX-*01		ZDX-*86	ZDX-*86				ZDX-*62	ZDX-*62	
ZDY	Position Difference Y Axis		ZDY-*11	ZDY-*01		ZDY-*87	ZDY-*87				ZDY-*63	ZDY-*63	
ZDZ	Position Difference Z Axis		ZDZ-*12	ZDZ-*01		ZDZ-*88	ZDZ-*88				ZDZ-*64	ZDZ-*64	

Table A.3.1.2 — Allowable succeeding letters for readout/passive functions and first letters P to VZZ (1) (4b)

Note: Numbers in parentheses refer to explanatory notes in Clause A.16.3.

First Letters (2) Measured/Initiating Variables w/ and w/o Modifiers		A			B	E	G	I	L	N	O	P	Q	R	W	X
		Absolute Alarm	Function Modifier	Deviation Alarm	User's Choice (4a)	Primary Element	Gauge, Glass	Indicate	Light	User's Choice (4a)	Orifice, Restrict- ion	Point (Test Conn.)	Integrate, Total	Record	Well, Probe	Unclass- ified
		A	[*] (3) (4d)	AD												
P	Pressure	PA[*]	[*] = Alarm and other Function Modifier	PAD[*]		PE	PG (5)	PI	PL		NA	PP	NA	PR	NA	PX
PD	Pressure Differential	PDA[*]		PDAD[*]		PDE	PDG (5)	PDI	PDL		NA	NA	NA	PDR	NA	PDX
PF	Pressure Ratio	PFA[*]		PFAD[*]		PE	NA	PFI	NA		NA	NA	NA	PFR	NA	PFX
PJ	Pressure Scan	PJA[*]			NA	PE	NA	NA	NA		NA	NA	NA	PJR	NA	NA
PK	Pressure Rate of Change	PKA[*]		PKAD[*]		PE	NA	PKI	PKL		NA	NA	NA	PKR	NA	PKX
PS	Pressure Safety	NA			NA	PSE (6)	NA	NA	NA	NA	NA	NA	NA	NA	NA	NA
PZ	Pressure(SIS)	PZA[*]			NA	PZE	NA	PZI	PZL		NA	PZP	NA	BZR	BZW	NA
Q	Quantity	QA[*]			QAD[*]	QE	NA	QI	QL		NA	NA	QQ	QR	NA	QX
QQ	Quantity Totalize	QQA[*]			NA	QE	NA	QQI	QQL		NA	NA	NA	QQR	NA	QQX
R	Radiation	RA[*]		High-High	RAD[*]	RE	RG	RI	RL		NA	RP	RQ	RR	NA	RX
RQ	Radiation Totalize	RQA[*]		High	NA	RE	NA	RQI	RQL		NA	NA	NA	RQR	NA	RQX
RZ	Radiation(SIS)	RZA[*]		High	NA	RZE	NA	RZI	RZL		NA	RZP	NA	BZR	BZW	NA
S	Speed, Frequency	SA[*]		Middle	SAD[*]	SE	SG	SI	SL		NA	SP	NA	SR	NA	SX
SZ	Speed(SIS)	SZA[*]		M	NA	SZE	NA	SZI	SZL		NA	SZP	NA	BZR	BZW	NA
T	Temperature	TA[*]		Low	TAD[*]	TE	TG (5)	TI	TL		NA	TP	NA	TR	TW	TX
TD	Temperature Differential	TDA[*]		L	TDAD[*]	TDE	TDG (5)	TDI	TDL		NA	NA	NA	TDR	NA	TDX
TF	Temperature Ratio	TFA[*]		Low-Low	TFAD[*]	TE	NA	TFI	NA		NA	NA	NA	TFR	NA	TFX
TJ	Temperature Scan	TJA[*]		LL	NA	TJE	NA	TJI	NA		NA	NA	NA	TJR	NA	TJX
TK	Temperature Rate of	TKA[*]		Open	TKAD[*]	TE	NA	TKI	NA		NA	NA	NA	TKR	NA	TKX
TS	Temperature Safety	NA		Close	NA	TSE (6)	NA	NA	NA		NA	NA	NA	NA	NA	NA
TZ	Temperature(SIS)	TZA[*]		C	NA	TZE	NA	TZI	TZL		NA	TZP	NA	TZR	TZW	NA
U	Multivariable	UA[*]		Run	NA	NA	NA	UI	NA		NA	NA	NA	UR	NA	UX
UJ	Multivariable Scan	UJA[*]		R	NA	NA	NA	UJI	NA		NA	NA	NA	UJR	NA	UJX
UZ	Multivariable(SIS)	UZA[*]	Stop	NA	UZE	NA	UZI	UZL		NA	UZP	NA	UZR	UZW	NA	
V	Vibr., Mach. Analysis	VA[*]	S	VAD[*]	VE	VG	VI	VL		NA	VP	NA	VR	NA	VX	
VZ	Vibration(SIS)	VZA[*]	Unclassified	NA	VZE	NA	VZI	VZL		NA	NA	NA	VZR	NA	NA	
VX	Vibration X-Axis	VXA[*]	X	VXAD[*]	VXE	VXG	VXI	VXL		NA	VXP	NA	VXR	NA	VXX	
VY	Vibration Y-Axis	VYA[*]		VYAD[*]	VYE	VYG	VYI	VYL		NA	VYP	NA	VYR	NA	VYX	
VZ	Vibration Z-Axis	VZA[*]		VZAD[*]	VZE	VZG	VZI	VZL		NA	VZP	NA	VZR	NA	VZX	
VZX	Vibration X-Axis(SIS)	VZA[*]		NA	VZE	NA	VZI	VZL		NA	VZP	NA	VZR	NA	NA	
VZY	Vibration Y-Axis(SIS)	VZA[*]		NA	VZE	NA	VZI	VZL		NA	VZP	NA	VZR	NA	NA	
VZZ	Vibration Z-Axis(SIS)	VZA[*]		NA	VZE	NA	VZI	VZL		NA	VZP	NA	VZR	NA	NA	

Table A.3.1.3 — Allowable succeeding letters for readout/passive functions and first letters W to ZDZ (1) (4b)

Note: Numbers in parentheses refer to explanatory notes in Clause A.16.3.

First Letters (2) Measured/Initiating Variables w/ and w/o Modifiers		A			B	E	G	I	L	N	O	P	Q	R	W	X	
		Absolute Alarm	Function Modifier	Deviation Alarm	User's Choice (4a)	Primary Element	Gauge, Glass	Indicate	Light	User's Choice (4a)	Orifice, Restriction	Point (Test Conn.)	Integrate, Total	Record	Well, Probe	Unclassified	
		A	[*] (3) (4d)	AD													
W	Weight, Force	WA[*]	[*] = Alarm and other Function Modifier	WAD[*]		WE	WG	WI	WL		NA	NA	NA	WR	NA	WX	
WZ	Force(SIS)	WZA[*]		NA		WZE	NA	NA	NA		NA	NA	NA	XR	NA	NA	
WD	Weight Differential	WDA[*]		WDAD[*]		WE	NA	WDI	WDL		NA	NA	NA	WDR	NA	WDX	
WF	Weight Ratio	WFA[*]		WFAD[*]		WE	NA	WFI	NA		NA	NA	NA	WFR	NA	WFX	
WK	Weight Loss (Gain)	WKA[*]		WKAD[*]		WE	NA	WKI	WQL		NA	NA	NA	WKR	NA	WKX	
WQ	Weight Total	WQA[*]		WQAD[*]		WE	NA	WQI	NA		NA	NA	NA	WQR	NA	WQX	
WX	Force X Axis	WXA[*]		WXAD[*]		WXE	NA	WXI	WXL		NA	NA	NA	WXR	NA	WXX	
WY	Force Y Axis	WAY[*]		WYAD[*]		WYE	NA	WAI	WYL		NA	NA	NA	WAR	NA	WAX	
WZ	Force Z Axis	WZA[*]		WZAD[*]		WZE	NA	WZI	WZL		NA	NA	NA	WZR	NA	WZX	
WZX	Force X Axis(SIS)	WZXA[*]		NA		WZE	NA	WZI	WZXL		NA	WZXP	NA	WZXR	NA	NA	
WZY	Force Y Axis(SIS)	WZYA[*]		NA		WZE	NA	WZI	WZYL		NA	WZYP	NA	WZYR	NA	NA	
WZZ	Force Z Axis(SIS)	WZZA[*]		NA		WZE	NA	WZI	WZZL		NA	WZZP	NA	WZZR	NA	NA	
X	Unclassified	XA[*]		XAD[*]		XE	XG	XI	XL		NA	XP	XQ	XR	XW	XX	
Y	Event, State, Presence	YA[*]		YAD[*]		YE	NA	YI	YL		NA	NA	NA	YR	NA	YX	
YZ	Event, State(SIS)	YZA[*]		YZAD[*]		YZE	NA	YZI	YZL		NA	NA	NA	YZR	NA	YZX	
Z	Position, Dimension	ZA[*]		ZAD[*]		ZE	ZG	ZI	ZL		NA	NA	NA	ZR	NA	ZX	
ZZ	Position(SIS)	ZZA[*]	NA		ZZE	NA	ZZI	ZZL		NA	NA	NA	ZZR	NA	NA		
ZX	Position X Axis	ZXA[*]	ZXAD[*]		ZXE	ZXG	ZXI	ZXL		NA	NA	NA	ZXR	NA	ZXX		
ZY	Position Y Axis	ZYA[*]	ZYAD[*]		ZYE	ZYG	ZYI	ZYL		NA	NA	NA	ZYR	NA	ZYX		
ZZ	Position Z Axis	ZZA[*]	ZZAD[*]		ZZE	NA	ZZI	ZZL		NA	NA	NA	ZZR	NA	ZZX		
ZZX	Position X Axis(SIS)	ZZXA[*]	NA		ZZXE	NA	ZZXI	ZZXL		NA	ZZXP	NA	ZZXR	NA	NA		
ZZY	Position Y Axis(SIS)	ZZYA[*]	NA		ZZYE	NA	ZZYI	ZZYL		NA	ZZYP	NA	ZZYR	NA	NA		
ZZZ	Position Z Axis(SIS)	ZZZA[*]	NA		ZZZE	NA	ZZZI	ZZZL		NA	ZZZP	NA	ZZZR	NA	NA		
ZD	Position Difference	ZDA[*]	ZDAD[*]		ZDE	ZDG	ZDI	ZDL		NA	NA	NA	ZDR	NA	ZDX		
ZDX	Position Difference X Axis	ZDXA[*]	ZDXAD[*]		ZDXE	ZDXG	ZDXI	ZDXL		NA	NA	NA	ZDXR	NA	ZDXX		
ZDY	Position Difference Y Axis	ZDYA[*]	ZDYAD[*]		ZDYE	ZDYG	ZDYI	ZDYL		NA	NA	NA	ZDYR	NA	ZDYX		
ZDZ	Position Difference Z Axis	ZDZA[*]	ZDZAD[*]		ZDZE	ZDZG	ZDZI	ZDZL		NA	NA	NA	ZDZR	NA	ZDZX		

Table A.3.2.2 — Allowable succeeding letters for output/active function letters and first letters P to VZZ (1) (4b2)

Note: Numbers in parentheses refer to explanatory notes in A.16.3.

First Letters Measured/Initiating Variables w/ and w/o Modifiers		B	C				K	N	S		T			U	V	X	Y	Z
		User's Choice (4a)	Control	Indicate Control	Record Control	Control Valve	Control Station	User's Choice 4a)	Switch	Function Modifier	Transmit	Indicating Transmit	Recording Transmit	Multi- function	Valve Dampener Louver	Unclass- ified	Compute, Convert Relay	Actuator, Drive
			C (7)	IC (8)	RC (8)	CV (9)			S	[*] (3) (4d)	T	IT	RT					
P	Pressure		PC	PIC	PRC	PCV (11)	PK		PS[*]				PU	PV	PX	PY	PZ	
PD	Pressure Differential		PDC	PDIC	PDRC	PDCV	PDK		PDS[*]				PDU	PDV	PDX	PDY	PDZ	
PF	Pressure Ratio		PFC	PFIC	PFRC	NA	PFK		PFS[*]				PFU	PFV	PFX	PFY	PFZ	
PJ	Pressure Scan		NA	NA	NA	NA	NA		PJS[*]				NA	NA	NA	NA	NA	
PK	Pressure Rate of Change		PKC	PKIC	PKRC	NA	PKK		PKS[*]				PKU	PKV	PKX	PKY	PKZ	
PS	Pressure Safety		NA	NA	NA	PSV	NA		NA				NA	PSV (9)	NA	NA	NA	
PZ	Pressure(SIS)		PZC	PZIC	PZRC	NA	NA		PZS[*]				PZU	PZV	PZX	PZY	PZZ	
Q	Quantity		QC	QIC	QRC	NA	QK		QS[*]				QU	QV	QX	QY	QZ	
QQ	Quantity Totalize		QQC	QQIC	QQRC	NA	QQK		QQS[*]	High-High			QQU	QQV	QQX	QQY	QQZ	
R	Radiation		RC	RIC	RRC	NA	RK		RS[*]	HH			RU	RV	RX	RY	RZ	
RQ	Radiation Totalize		RQC	RQIC	RQRC	NA	RQK		RQS[*]	High			RQU	RQV	RQX	RQY	RQZ	
RZ	Radiation(SIS)		RZC	RZIC	RZRC	NA	NA		RZS[*]	H			RZU	RZV	RZX	RZY	RZZ	
S	Speed, Frequency		SC	SIC	SRC	SCV	SK		SS[*]	Middle			SU	SV	SX	SY	SZ	
SZ	Speed(SIS)		SZC	SZIC	SZRC	SZCV	NA		SZS[*]	M			SZU	SZV	SZX	SZY	SZZ	
T	Temperature		TC	TIC	TRC	TCV	TK		TS[*]]	Low			TU	TV	TX	TY	TZ	
TD	Temperature Differential		TDC	TDIC	TDRC	NA	TDK		TDS[*]	L			TDU	TDV	TDX	TDY	TDZ	
TF	Temperature Ratio		TFC	TFIC	TFRC	NA	TFK		TFS[*]	Low-Low			TFU	TFV	TFX	TFY	TFZ	
TJ	Temperature Scan		NA	NA	NA	NA	NA		TJS[*]	LL			NA	NA	NA	NA	NA	
TK	Temperature Rate of Change		TKC	TKIC	TKRC	NA	TKK		TKS[*]	Open			NA	NA	NA	NA	NA	
TS	Temperature Safety		NA	NA	NA	TSV	NA		NA	O			NA	NA	NA	NA	NA	
TZ	Temperature(SIS)		TZC	TZIC	TZRC	NA	NA		TZS[*]	Close			NA	TSV (9)	NA	NA	NA	
U	Multivariable		UC	UIC	URC	NA	NA		US[*]	C			NA	NA	NA	NA	NA	
UJ	Multivariable Scan		NA	NA	NA	NA	NA		NA	Run			UU	UV	UX	UY	UZ	
UZ	Multivariable(SIS)		UZC	UZIC	UZRC	NA	NA		UZS[*]	R			NA	NA	NA	NA	NA	
V	Vibr., Mach. Analysis		VC	VIC	VRC	NA	VK		VS[*]	Stop			NA	NA	NA	NA	NA	
VZ	Vibration(SIS)		VZC	VZIC	VZRC	NA	NA		VZS[*]	S			VZU	NA	VX	VY	NA	
VX	Vibration X-Axis		VXC	VXIC	VXRC	NA	NA		VXS[*]	Unclassified			VZV	NA	VZX	VZY	NA	
VY	Vibration Y-Axis		VYC	VYIC	VYRC	NA	NA		VYS[*]	X			VZT	NA	VZX	VZY	NA	
VZ	Vibration Z-Axis		VZC	VZIC	VZRC	NA	NA		VZS[*]				VZU	NA	VZX	VZY	NA	
VZX	Vibration X-Axis(SIS)		VZXC	VZXIC	VZXRC	NA	NA		VZXS[*]				VZU	NA	VZXX	VZXY	NA	
VZY	Vibration Y-Axis(SIS)		VZYC	VZYIC	VZYRC	NA	NA		VZYS[*]				VZU	NA	VZXX	VZXY	NA	
VZZ	Vibration Z-Axis(SIS)		VZZC	VZZIC	VZZRC	NA	NA		VZZS[*]				VZU	NA	VZXX	VZXY	NA	

Table A.3.2.3 — Allowable succeeding letters for output/active function letters and first letters W to ZDZ (1) (4b2)

Note: Numbers in parentheses refer to explanatory notes in A.16.3.

First Letters Measured/Initiating Variables w/ and w/o Modifiers		B	C				K	N	S		T			U	V	X	Y	Z
		User's Choice (4a)	Control	Indicate Control	Record Control	Control Valve	Control Station	User's Choice (4a)	Switch	Function Modifier	Transmit	Indicating Transmit	Recording Transmit	Multi- function	Valve Damper Louver	Unclass- ified	Compute, Convert Relay	Actuator, Drive
			C (7)	IC (8)	RC (8)	CV (9)			S	[*] (3) (4d)	T	IT	RT					
W	Weight, Force		WC	WIC	WRC	WCV	WK		WS[*]									
WZ	Force(SIS)		WZC	WZIC	WZRC	NA	NA		WZS[*]									
WD	Weight Differential		WDC	WDIC	WDRC	NA	WDK		WDS[*]									
WF	Weight Ratio		WFC	WFIC	WFRC	NA	WFK		WFS[*]									
WK	Weight Loss (Gain)		WKC	WKIC	WKRC	NA	WKK		WKS[*]									
WQ	Weight Total		WQC	WQIC	WQRC	NA	WQK		WQS[*]									
WX	Force X Axis		WXC	WXIC	WXRC	NA	WXK		WXS[*]									
WY	Force Y Axis		WYC	WYIC	WYRC	NA	WYK		WYS[*]									
WZ	Force Z Axis		WZC	WZIC	WZRC	NA	WZK		WZS[*]									
WZX	Force X Axis(SIS)		WZXC	WZXIC	WZXRC	NA	NA		WZXS[*]									
WZY	Force Y Axis(SIS)		WZYC	WZYIC	WZYRC	NA	NA		WZYS[*]									
WZZ	Force Z Axis(SIS)		WZZC	WZZIC	WZZRC	NA	NA		WZZS[*]									
X	Unclassified		XC	XIC	XRC	NA	XK		XS[*]									
Y	Event, State, Presence		YC	YIC	YRC	NA	YK		YS[*]									
YZ	Event, State(SIS)		YZC	YZIC	YZRC	NA	NA		YZS[*]									
Z	Position, Dimension		ZC	ZIC	ZRC	NA	ZK		ZS[*]									
ZZ	Position(SIS)		ZZC	ZZIC	ZZRC	NA	NA		ZZS[*]									
ZX	Position X Axis		ZXC	ZXIC	ZXRC	NA	ZXK		ZXS[*]									
ZY	Position Y Axis		ZYC	ZYIC	ZYRC	NA	ZYK		ZYS[*]									
ZZ	Position Z Axis		ZZC	ZZIC	ZZRC	NA	NA		ZZS[*]									
ZZX	Position X Axis(SIS)		ZZXC	ZZXIC	ZZXRC	NA	NA		ZZXS[*]									
ZZY	Position Y Axis(SIS)		ZZYC	ZZYIC	ZZYRC	NA	NA		ZZYS[*]									
ZZZ	Position Z Axis(SIS)		ZZZC	ZZZIC	ZZZRC	NA	NA		ZZZS[*]									
ZD	Position Difference		ZDC	ZDIC	ZDRC	NA	ZDK		ZDS[*]									
ZDX	Position Diff. X Axis		ZDXC	ZDXIC	ZDXRC	NA	ZDXK		ZDXS[*]									
ZDY	Position Diff. Y Axis		ZDYC	ZDYIC	ZDYRC	NA	ZDYK		ZDYS[*]									
ZDZ	Position Diff. Z Axis		ZDZC	ZDZIC	ZDZRC	NA	ZDZK		ZDZS[*]									

[*] =
Function
Modifier
High-High
HH
High
H
Middle
M
Low
L
Low-Low
LL
Open
O
Close
C
Run
R
Stop
S
Unclassified
X

Table A.4 — Loop and Identification Tag Number suffixes (1) (2)

Note: Numbers in parentheses refer to explanatory notes in Clause A.16.4.

Loop Identification Number Suffixes(Bold-Italic)			Identification/Tag Number suffixes (Bold-Underlined)						
First Loop Suffix	After loop numbers	After first letters	Case 1 — Different services (3)						
			Two devices with loop suffix after			Four devices with loop suffix after			
			None	Numbers	Letters	None	Numbers	Letters	
None	F*01		FV*01- <u>1</u>				FV*01- <u>1A</u>		
							FV*01- <u>1B</u>		
			FV*01- <u>2</u>				FV*01- <u>2A</u>		
							FV*01- <u>2B</u>		
Alpha	F*01A	F-A*01		FV*01A- <u>1</u>	FV-A*01- <u>1</u>		FV*01A- <u>1A</u>	FV-A*01- <u>1A</u>	
				FV*01A- <u>2</u>	FV-A*01- <u>2</u>		FV*01A- <u>1B</u>	FV-A*01- <u>1B</u>	
				FV*01B- <u>1</u>	FV-B*01- <u>1</u>		FV*01A- <u>2A</u>	FV-A*01- <u>2A</u>	
							FV*01A- <u>2B</u>	FV-A*01- <u>2B</u>	
				FV*01B- <u>2</u>	FV-B*01- <u>2</u>		FV*01B- <u>1A</u>	FV-B*01- <u>1A</u>	
							FV*01B- <u>1B</u>	FV-B*01- <u>1B</u>	
				FV*01B- <u>2A</u>	FV-B*01- <u>2A</u>				
				FV*01B- <u>2B</u>	FV-B*01- <u>2B</u>				
Numeric	F*01-7	F-7*01		FV*01- <u>7-1</u>	FV-7*01- <u>1</u>		FV*01- <u>7-1A</u>	FV-7*01- <u>1A</u>	
				FV*01- <u>7-2</u>	FV-7*01- <u>2</u>		FV*01- <u>7-1B</u>	FV-7*01- <u>1B</u>	
				FV*01- <u>2-1</u>	FV-2*01- <u>1</u>		FV*01- <u>7-2A</u>	FV-7*01- <u>2A</u>	
							FV*01- <u>7-2B</u>	FV-7*01- <u>2B</u>	
				FV*01- <u>2-2</u>	FV-2*01- <u>2</u>		FV*01- <u>2-1A</u>	FV-2*01- <u>1A</u>	
							FV*01- <u>2-1B</u>	FV-2*01- <u>1B</u>	
				FV*01- <u>2-2A</u>	FV-2*01- <u>2A</u>				
				FV*01- <u>2-2B</u>	FV-2*01- <u>2B</u>				
			Case 2 — Same service (3)						
			Two devices with loop suffix after			Four devices with loop suffix after			
			None	Numbers	Letters	None	Numbers	Letters	
None			FV*01- <u>A</u>				FV*01- <u>A1</u>		
							FV*01- <u>B1</u>		
			FV*01- <u>B</u>				FV*01- <u>A2</u>		
							FV*01- <u>B2</u>		
Alpha				FV*01A- <u>A</u>	FV-A*01- <u>A</u>		FV*01A- <u>A1</u>	FV-A*01- <u>A1</u>	
				FV*01A- <u>B</u>	FV-A*01- <u>B</u>		FV*01A- <u>A2</u>	FV-A*01- <u>A2</u>	
				FV*01B- <u>A</u>	FV-B*01- <u>A</u>		FV*01A- <u>B1</u>	FV-A*01- <u>B1</u>	
							FV*01A- <u>B2</u>	FV-A*01- <u>B2</u>	
				FV*01B- <u>B</u>	FV-B*01- <u>B</u>		FV*01B- <u>A1</u>	FV-B*01- <u>A1</u>	
							FV*01B- <u>A2</u>	FV-B*01- <u>A2</u>	
				FV*01B- <u>B1</u>	FV-B*01- <u>B1</u>				
				FV*01B- <u>B2</u>	FV-B*01- <u>B2</u>				
Numeric				FV*01- <u>7-A</u>	FV-7*01- <u>A</u>		FV*01- <u>7-A1</u>	FV-7*01- <u>A1</u>	
				FV*01- <u>7-B</u>	FV-7*01- <u>B</u>		FV*01- <u>7-A2</u>	FV-7*01- <u>A2</u>	
				FV*01- <u>2-A</u>	FV-2*01- <u>A</u>		FV*01- <u>7-B1</u>	FV-7*01- <u>B1</u>	
							FV*01- <u>7-B2</u>	FV-7*01- <u>B2</u>	
				FV*01- <u>2-B</u>	FV-2*01- <u>B</u>		FV*01- <u>2-A1</u>	FV-2*01- <u>A1</u>	
							FV*01- <u>2-A2</u>	FV-2*01- <u>A2</u>	
				FV*01- <u>2-B1</u>	FV-2*01- <u>B1</u>				
				FV*01- <u>2-B2</u>	FV-2*01- <u>B2</u>				

This page intentionally left blank.

Annex B Graphic symbol guidelines (informative annex)

B.1 Graphic symbols

- B.1.1 This informative annex to the standard describes the use of graphic symbols that are used to depict instrument loop devices and functions, application software functions, and the interconnections between them that is logical, unique, and consistent in application with a minimum of exceptions, special uses, or requirements.
- B.1.2 Graphic symbols, when used with identification letters and numbers constructed as described in Annex A, should as a minimum describe the functionality of, and if assigned a loop number provide a unique identity for, each device and function shown.

B.2 Instrument identification applied to graphic symbols

- B.2.1 Instrument identification applied to graphic symbols should include, as a minimum, an alphabetic functional identification to identify the functionality of devices and functions shown in the diagrams as described in Annex A.
- B.2.2 Tables A.3.1.1 through A.3.6.2 provide examples of allowable functional identifications.
- B.2.3 Brief explanatory notes or other text may be added adjacent to a symbol or in the note section of a drawing or sketch to clarify the meaning or purpose of a device or function.
- B.2.4 Loop Identification Number numerals, when assigned in accordance with A.6, complete the identity of the loop being shown.
- B.2.5 Lettering fonts should be similar to Arial Narrow and be a minimum of 3/32in(1.125mm) high and a maximum of 13 characters per inch wide.
- B.2.6 A Loop Number prefix should:
 - a) Not be used with bubbles on drawings but indicated in the note section.
 - b) Be used with bubbles if more than one prefix is being used.
 - c) Be used in text.

B.3 Examples of graphic symbols with assigned instrument/tag numbers

- B.3.1 Instrument bubble symbols should use the upper half of each symbol for Functional Identification Letters and the lower half of each symbol for Loop Numbers:
 - a) Five (5) characters or less:

 - b) Six (6) characters or more, relieve sides of bubble or enlarge bubble as required:

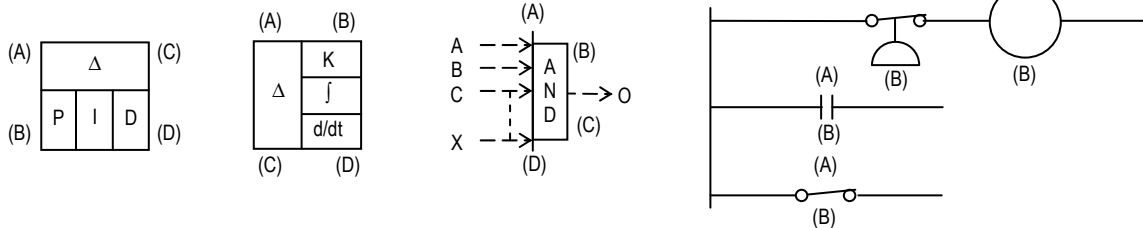

B.3.2 Functional diagramming, binary logic, and electrical schematic symbols should be tagged at either (A), (B), (C), or (D):



B.4 Graphic symbol applications

B.4.1 Graphic symbols provide representations of the instrumentation and functions required for process, machine, or equipment measurement, indication, control, modulation, and switching of variables by any or all of the following applications:

- Instrument diagrams
- Functional diagrams
- Binary logic diagrams
- Electrical schematics

B.4.2 The most common uses for:

- Instrument diagrams are process flow diagrams (PFDs), piping and instrumentation diagrams (P&IDs), engineering flow diagrams (EFDs), and mechanical flow diagrams (MFDs).
- Functional diagrams are instrument loop device and function details and application software details for microprocessor-based control and monitoring systems.
- Binary logic diagrams are complex, interlocking, and stepwise logic programming and application software for microprocessor-based binary logic systems.
- Electrical schematics are electrical diagrams for motor and other on-off control.

B.4.3 All of the applications may be used to prepare sketches and drawings for books, magazines, journals, and instruction and maintenance manuals.

B.5 Device and function symbols

B.5.1 Instrumentation devices and functions are constructed for sketches, drawings, and diagrams by the use of the generic bubble and other geometric symbols and specific graphic symbols found in Clause 5.

B.5.2 It is not necessary to show a symbol or a bubble for every device or function required by a loop if the need for the device or function or its tag number is clearly understood; for example:

- a) Symbols are not required, but may be used, for control valve positioners and stream sample conditioner components.
- b) Bubbles are not required, but may be used, for orifice plate, thermocouple, and control valve graphic symbols.

B.5.3 When “smart” drawings, such as computer-generated P&IDs, that are linked to instrument indexes or data sheets are used, a bubble or graphic symbol to which an instrument tag number is attached should be used for all devices and functions that are to be indexed or require data sheets.

B.6 Instrument diagram and functional diagram example

B.6.1 Process Flow Diagrams (PFDs) are developed by process engineers to provide basic process data and to describe process operation. Simple instrument diagrams are used to indicate the primary process control measurements and controlled streams required to operate the process. Process monitoring and alarm points and secondary and auxiliary controls and monitors are not shown but are added during the detailed process design and P&ID development.

B.6.2 A simple flow control requirement should be shown on a PFD as:

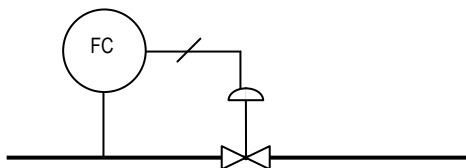

- a) Instrument tag numbers should not be assigned on PFDs.

B.6.3 A typical instrument diagram developed from the PFD diagram:

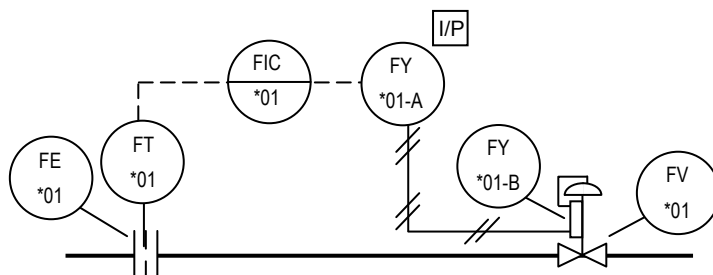

- a) Bubbles [FE-*01] and [FY-01-B] are optional and not recommended.
- b) Bubble [FV-*01] is optional but is recommended.

B.6.4 Typical equipment and function-oriented functional diagrams developed from the PFD diagram:

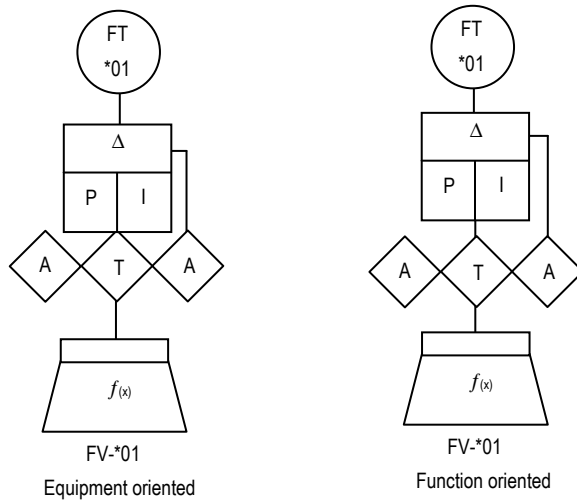

B.7 Process variable measurements

B.7.1 Process variable measurement devices are inserted in or mounted on pipelines and equipment to measure a physical property or to analyze a chemical composition, and include but are not limited to:

- a) Primary elements, such as orifice plates and thermocouples, that generate analog signals, position mechanical devices, or are used by transmitters to generate signals compatible with the control system.
- b) Transmitters with integral primary elements, such as vortex shedding flowmeters and filled-capillary temperature devices that generate signals compatible with the control system.

B.7.2 Process measurements are indicated by:

- a) Bubbles as shown in Table 5.2.1 for:
 - 1) Generic primary elements.
 - 2) Primary elements that do not have a graphic symbol in Table 5.2.3.
 - 3) Users who elect not to use graphic symbols from Table 5.2.3.
- b) Graphic symbols from Table 5.3.2.

B.7.3 Analyzer primary element located in a process slip stream or in a process stream or equipment with or without accessory devices, such as sample conditioners that contain components that are not normally shown, and with type of analyzer and component of interest noted at (**) and (***) respectively:

a) With sample conditioners:

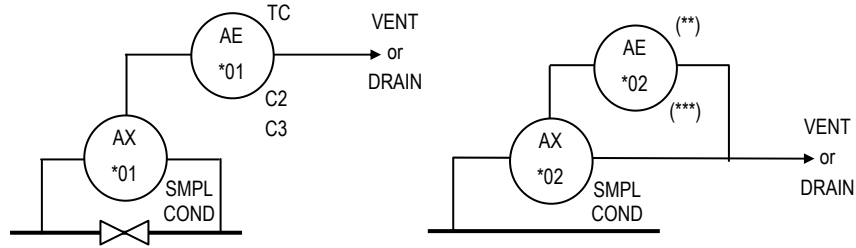

b) Without sample conditioners:

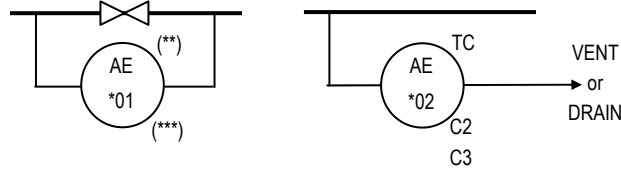

c) Analyzer primary element or transmitter inserted in process stream or equipment:

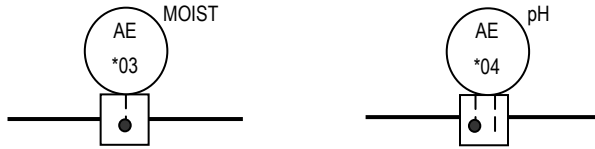

B.7.4 Orifice plate primary elements, with or without optional flow arrow, use generic orifice plate symbol with transmitter bubble connected to indicate orifice tap location for flange taps, corner taps, pipe taps, and vena contracta taps respectively:

a) Single process connection: corner taps, pipe taps, and vena contracta taps are indicated by notation:

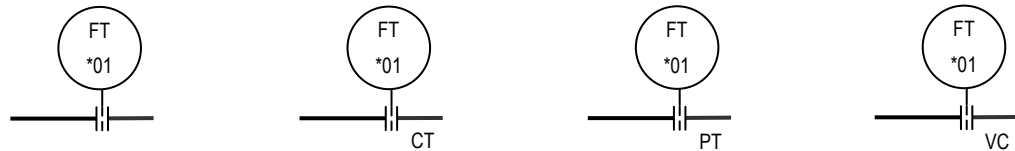

b) Double process connection, pipe taps and vena contracta taps are indicated by notation:

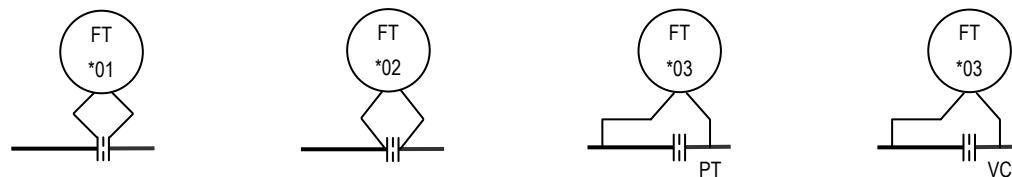

B.7.5 Process root block valves should be shown as required by the piping engineering group.

B.7.6 Orifice meter tubes or runs that are specified and requisitioned by the instrument group should be shown on drawings and sketches by:

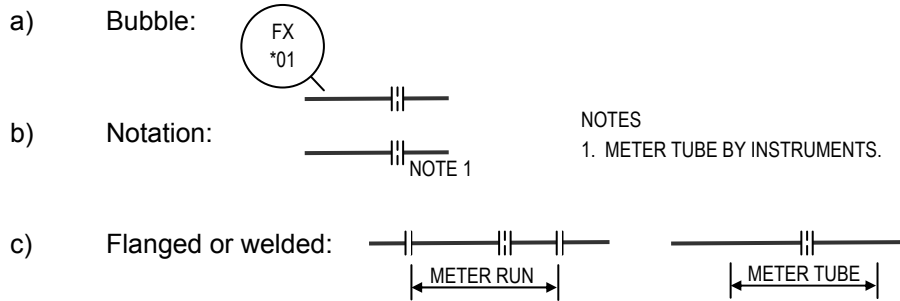

B.8 Final control elements

B.8.1 Final control elements installed in pipelines and equipment modulate or manipulate the process stream or equipment to affect the loop measured variable.

B.8.2 Final control elements include, but are not limited to, control valves, solenoid valves, louvers, dampers, motors, variable speed drives, and machine components.

B.8.3 Control valves are generally pneumatically operated and furnished with positioners that may:

- Be actuated by a pneumatic or an electronic signal.
- Not be shown if all control valves are furnished with positioners.

B.8.4 Control valves with pneumatic or electronic signal:

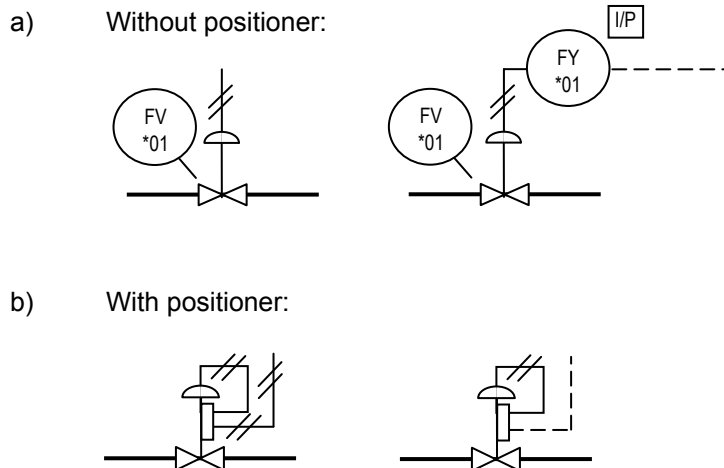

- Cross-hatches from positioner to actuator are optional.

c) With tripping solenoid, with and without positioner:

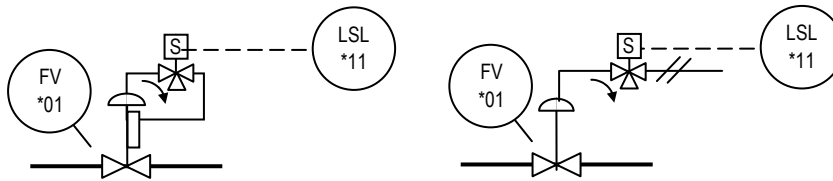

B.8.5 Instrumentation with integral components that:

a) Measure process variables and transmit control and other functions as an integral part of a transmitter:

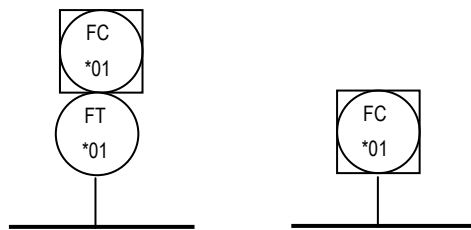

b) Manipulates control valves as an integral part of a control valve positioner:

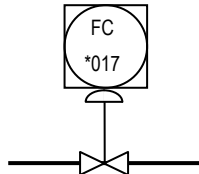

c) Is an integral assembly that contains a transmitter, a controller, and a control valve:

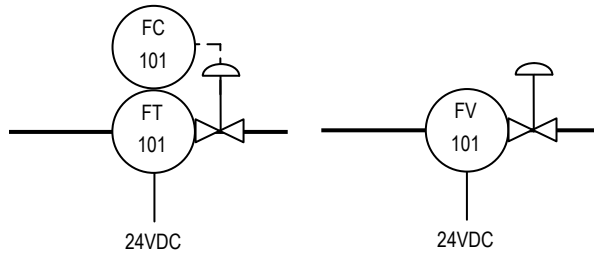

B.9 Common instrument-to-instrument signal connections

B.9.1 Pneumatic discrete instrumentation:

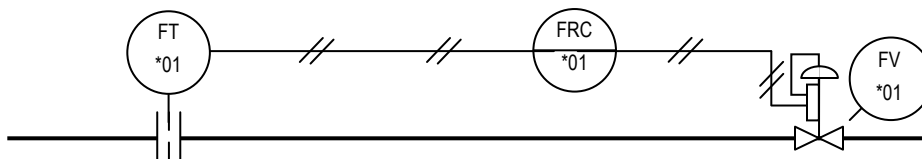

B.9.2 Electronic discrete instrumentation:

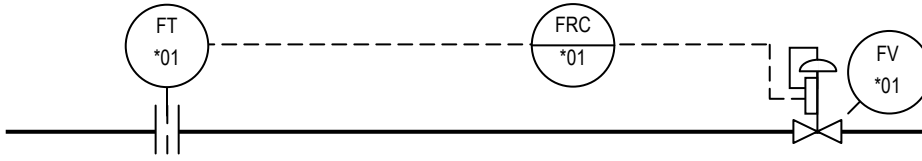

B.9.3 Shared display, shared control instrumentation:

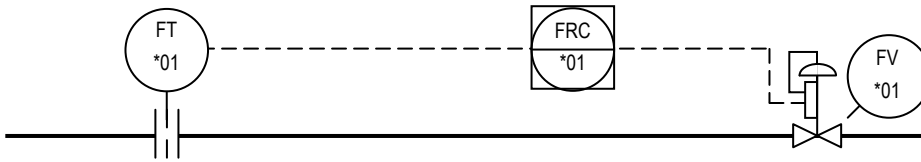

B.9.4 Shared display, shared control instrumentation, with diagnostic and calibration bus on field wiring:

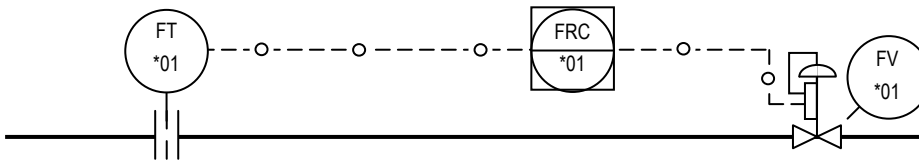

B.9.5 Shared display, shared control and wireless instrumentation:

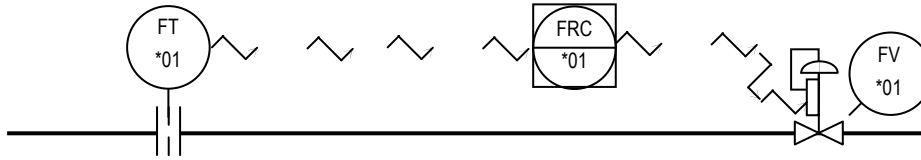

B.9.6 Shared display, shared control instrumentation, primary and alternate systems, no inter-bus communication:

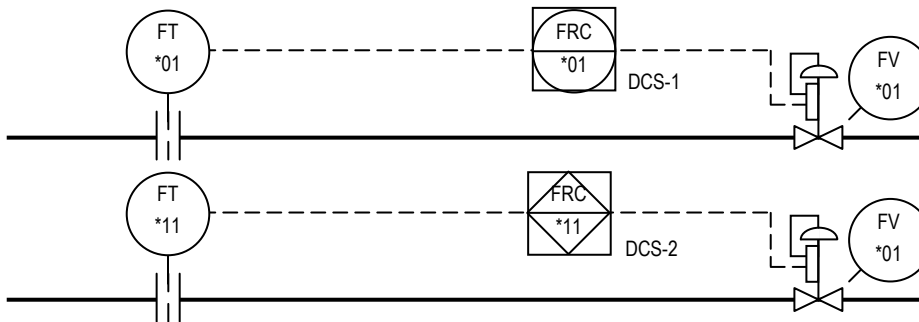

B.9.7 Shared display, shared control, primary and alternate systems, with inter-bus communication:

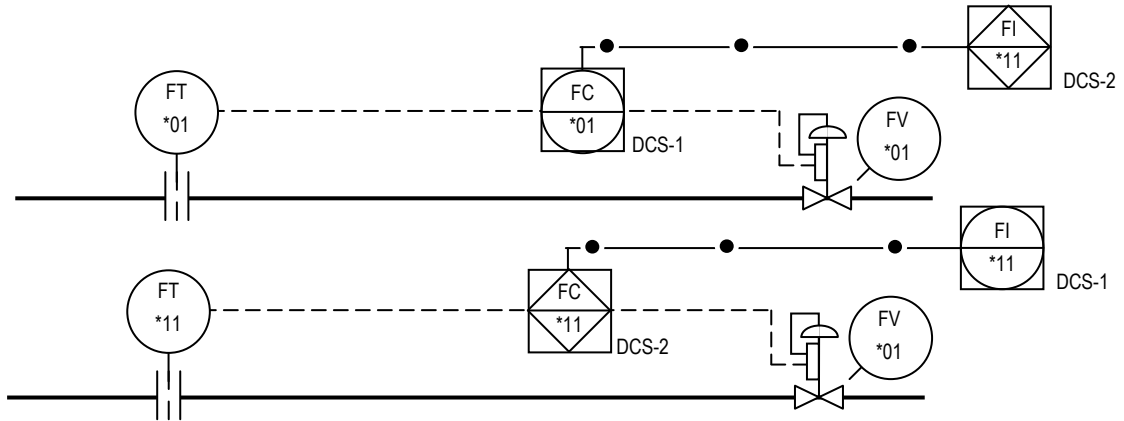

B.9.8 Shared display, shared control and fieldbus instrumentation, inter-bus communication:

a) Fieldbus transmitter/controller and electronic valve positioner:

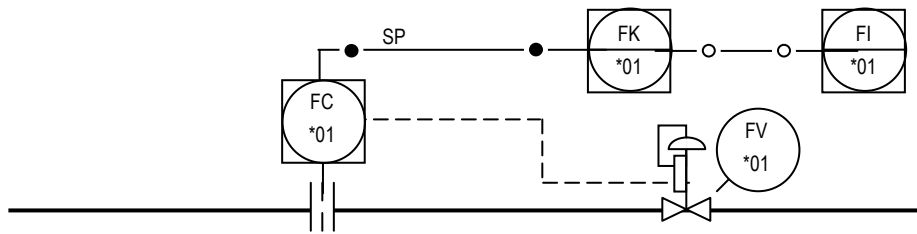

b) Fieldbus valve positioner/controller and electronic transmitter:

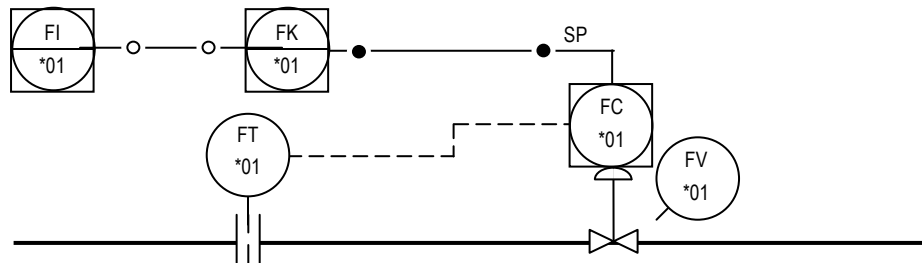

c) Fieldbus transmitter and valve positioner/controller:

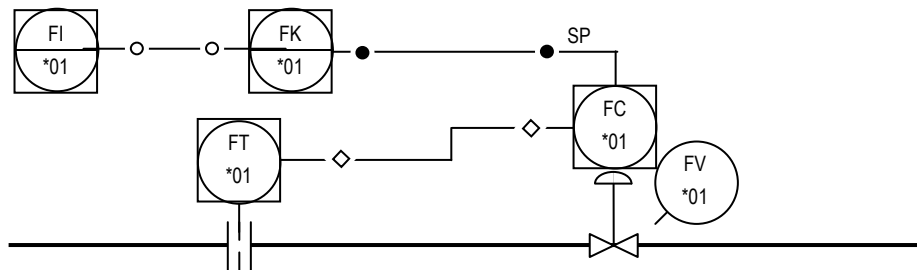

B.9.9 Fieldbus valve positioner/controller, transmitter, and indicator:

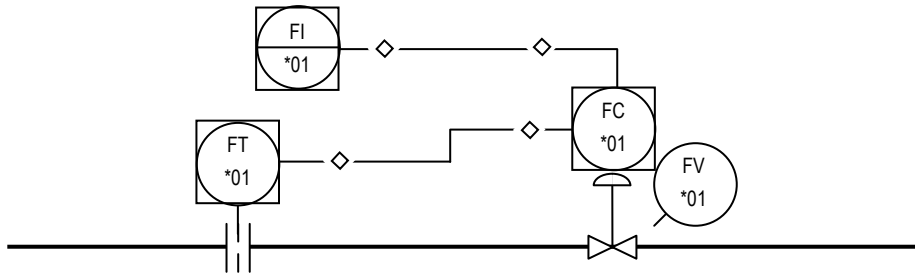

B.9.10 Fieldbus integral transmitter, controller, and valve positioner:

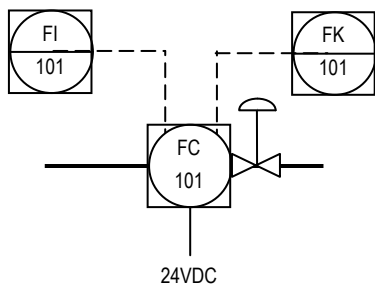

B.9.11 Instrument and functional diagrams should not be used to specifically identify signal tubing, wiring, and bus construction methods used to implement a monitoring and control system.

B.10 Function block symbols

B.10.1 Signal processing functions should be identified by a function block symbol from Table 7.6 that is:

- a) Appended to a bubble if an Instrument/Tag Number is required:

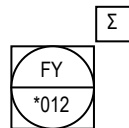

- b) Attached tangentially to the affected bubble and in line with the signal if the function is an integral part of the affected bubble:

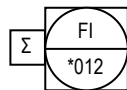

B.10.2 An example of a common application is the calculation of mass flow with an orifice plate primary element:

a) Separate devices or functions that require separate bubbles and tag numbers:

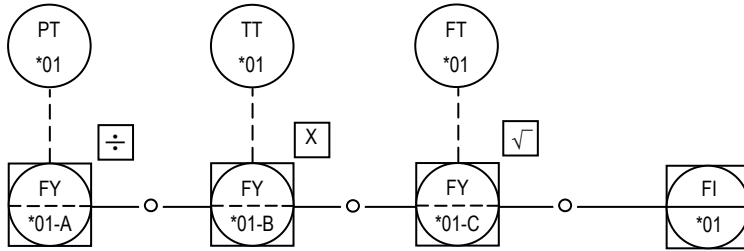

b) Separate devices or application software functions that do not require separate bubbles or tag numbers for each function:

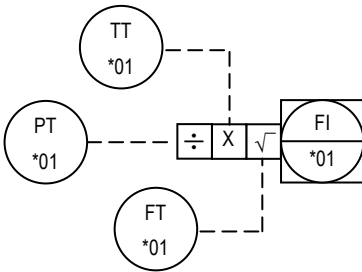

c) Integral devices or application software functions that do not require separate bubbles or tag numbers for each function:

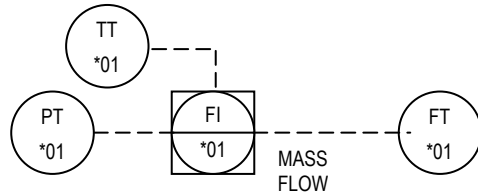

B.11 Alarm indicators

B.11.1 Shared control and monitor functions generally allow the indication of four configurable alarms for process variables and setpoint deviations.

B.11.2 Only alarms that are to be configured are shown.

B.11.3 Instrument diagramming:

a) Process variable alarms:

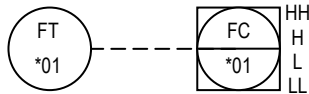

b) Process variable deviation from setpoint alarms:

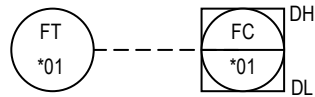

c) Process variable deviation from setpoint and process variable alarms:

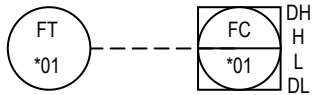

B.11.4 Functional diagramming:

a) Process variable alarms:

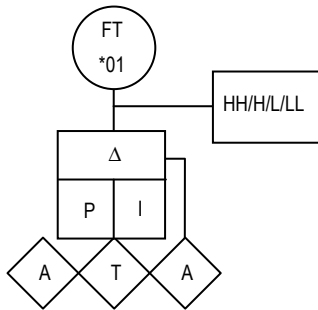

b) Process variable deviation from setpoint alarms:

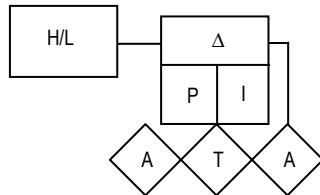

c) Process variable deviation from setpoint and process variable alarms:

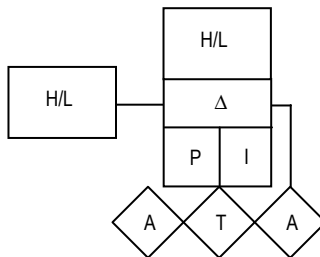

B.12 Multipoint, multivariable and multifunction instruments

B.12.1 Multipoint instruments are single or multivariable indicators or recorders that receive input signals from two (2) or more primary elements or transmitters.

B.12.2 Multivariable instruments are controllers that receive input signals from two (2) or more primary elements or transmitters and control one (1) manipulated variable.

B.12.3 Multifunction instruments are controllers that receive input signals from two (2) or more primary elements or transmitters and control two (2) or more manipulated variables.

B.12.4 Single variable or multivariable multipoint recorders for two (2) or three (3) points are drawn with bubbles either:

a) Tangent to each other in the same order, left to right, as the pen or pointer assignments:

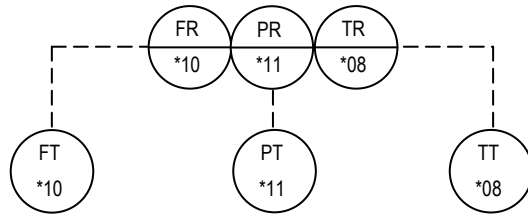

b) Separate from each other with pen number indicated and a note defining the multipoint instrument:

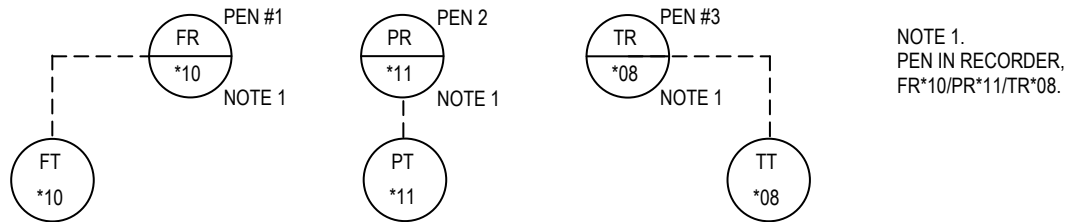

B.12.5 Multipoint indicators and recorders for four (4) or more points are drawn with bubbles separate from each other, with point number indicated by adding a suffix to the tag numbers:

a) Single variable:

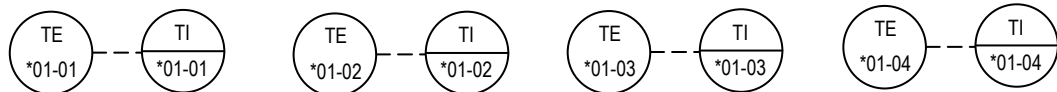

b) Multivariable:

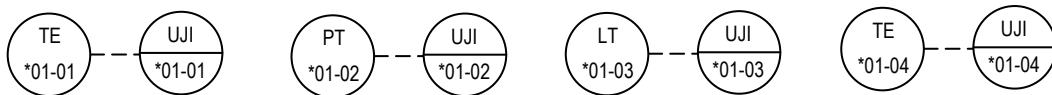

B.12.6 A multivariable controller example drawn with bubbles for each measured variable input, the output to the final control element, and measured variable indicators:

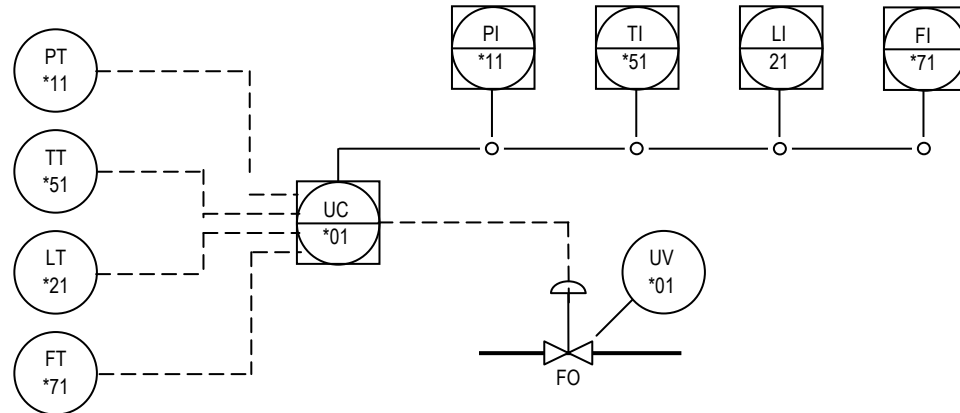

B.12.7 variable multifunction controller example drawn with bubbles for measured variable inputs, controller and indicator functions, and final control elements, for example:

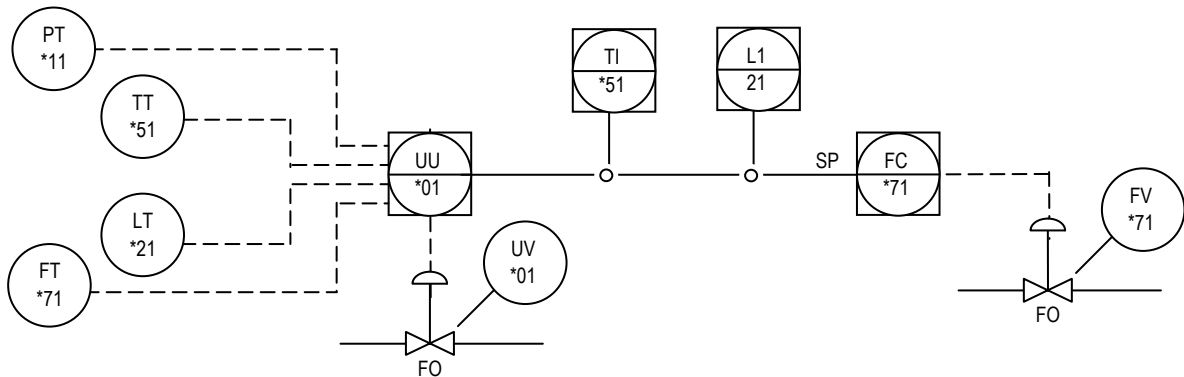

B.13 An example of instrument, functional, and electrical diagrams for a simple process

B.13.1 Process control description:

a) Process description:

- 1) Tank periodically fills with a liquid, in small and large volumes over long and short time periods.

b) Control description:

1) Control system design for:

- a) Small volumes for long and short periods should allow tank to fill to a high level to automatically start the pump and then to stop the pump at a low level.
- b) Large volumes for long periods should allow the pump to run continuously and maintain a fixed level with a level to flow cascade control loop.

- 2) Pump control is selected by a three-position Hand-Off-Auto selector switch:
 - a) Method a) selector switch is in "HAND" position.
 - b) Method b) selector switch is in "AUTO" position.
- 3) Pump should be stopped at any time:
 - a) Automatically if low level is exceeded.
 - b) By operating the stop pushbutton.
 - c) Switching the H-O-A selector to "OFF" position.

B.13.2 Instrument diagram:

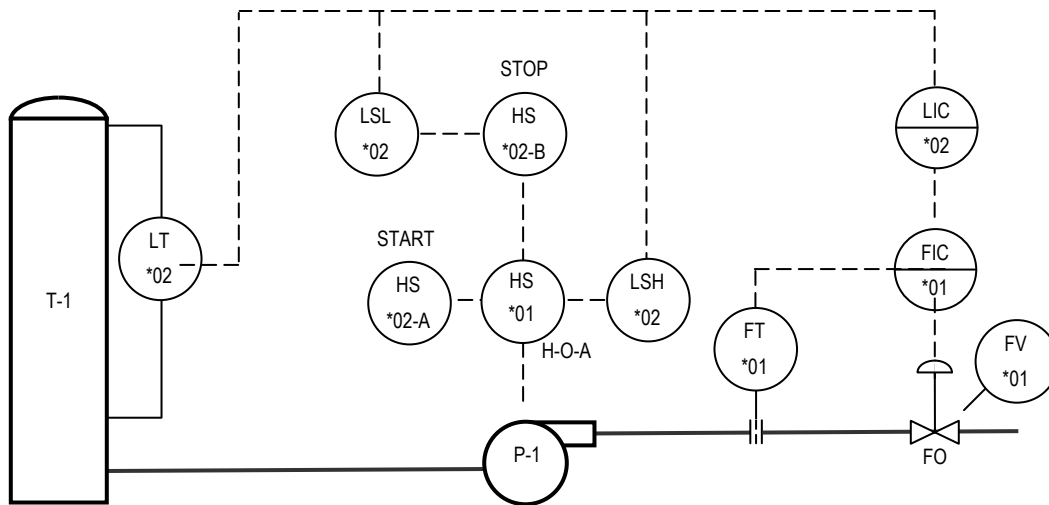

B.13.3 Functional diagram

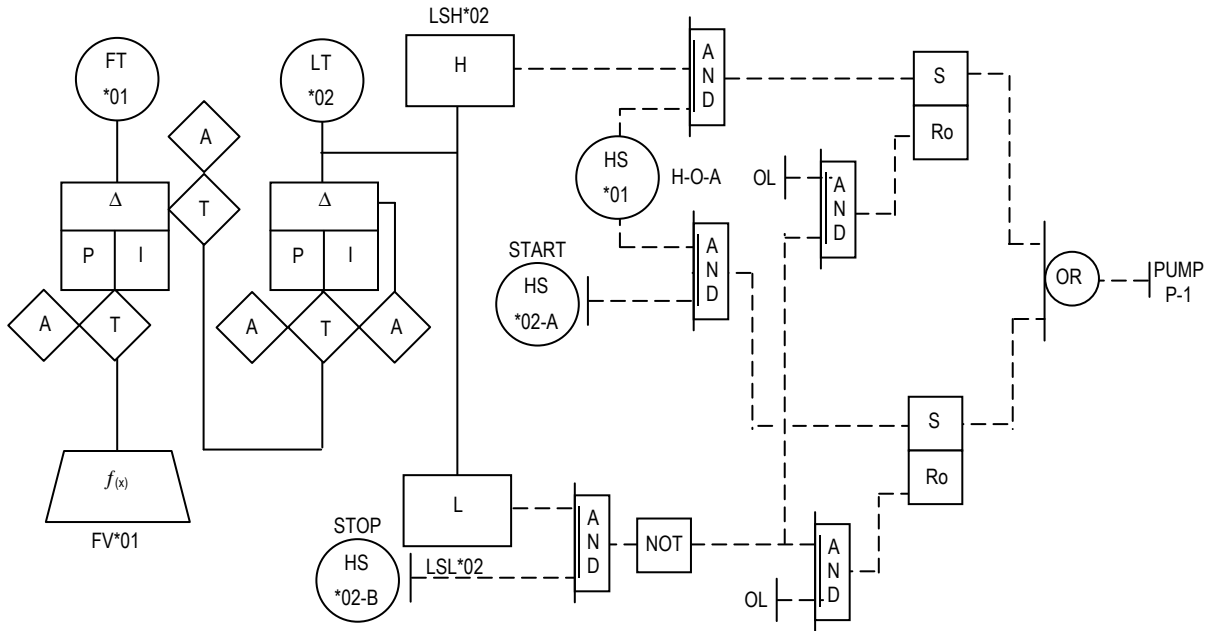

B.13.4 Electrical schematic diagram:

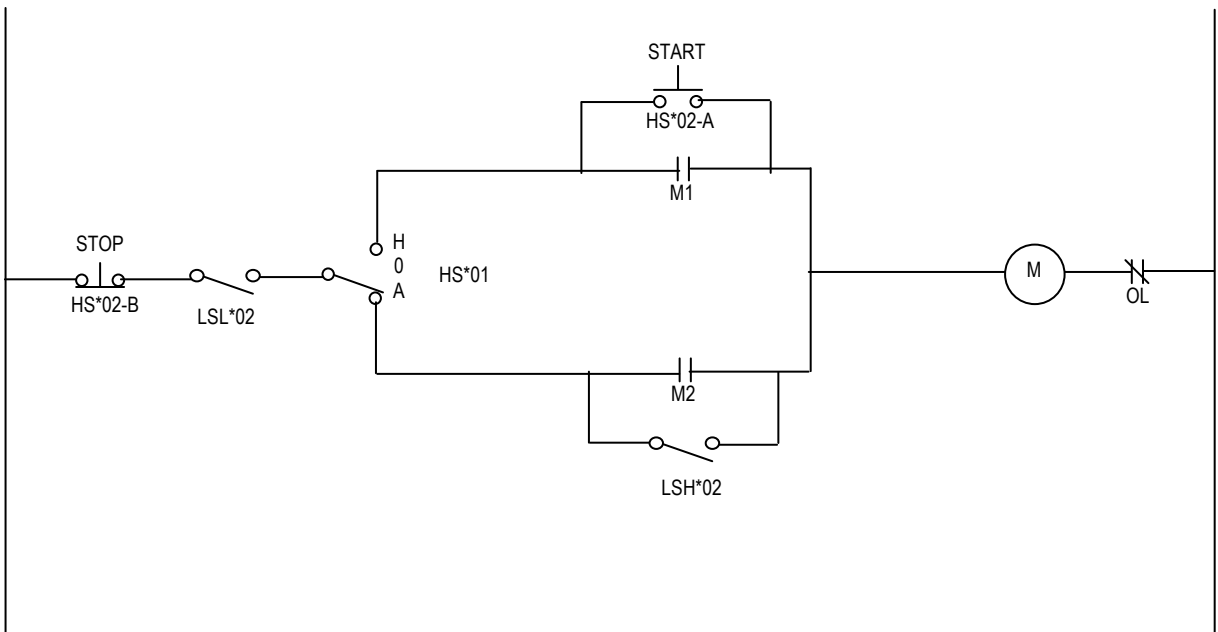

Developing and promulgating sound consensus standards, recommended practices, and technical reports is one of ISA's primary goals. To achieve this goal the Standards and Practices Department relies on the technical expertise and efforts of volunteer committee members, chairmen and reviewers.

ISA is an American National Standards Institute (ANSI) accredited organization. ISA administers United States Technical Advisory Groups (USTAGs) and provides secretariat support for International Electrotechnical Commission (IEC) and International Organization for Standardization (ISO) committees that develop process measurement and control standards. To obtain additional information on the Society's standards program, please write:

ISA
Attn: Standards Department
67 Alexander Drive
P.O. Box 12277
Research Triangle Park, NC 27709

ISBN: 978-1-936007-29-5